



**MAHARAJA INSTITUTE OF TECHNOLOGY  
THANDAVAPURA**

**LIBRARY AND INFORMATION CENTRE**

**VTU Question Papers**

**BE-I & II sem( Physics & Chemistry Cycle)**

**July/Aug-2022**

**2021 Scheme**

**Maharaja Institute of Technology Thandavapura**

**Just of NH-766,Mysore-ooty highway,Thandavapura( Vill & Post),Nanjangud Taluk,Mysore  
District-571302.**

<b>Sl.No.</b>	<b>Subject Code</b>	<b>Subject Title</b>	<b>Exam Date</b>
1	21MAT11	Calculus and differential equations	July/Aug -2022
2	21PSP13	Problem Solving Through Programming	July/Aug -2022
3	21MAT21	Advanced calculus and Numerical methods	July/Aug -2022
4	21PHY22	Engineering Physics	July/Aug -2022
5	21CHE22	Engineering Chemistry	July/Aug -2022
6	21PSP23	Problem Solving Through Programming	July/Aug-2022
7	21ELE23	Basic Electrical Engineering	July/Aug -2022
8	21ELN24	Basic Electronics and Communication Engineering	July/Aug -2022
9	21CIV24	Elements of Civil Engineering and Mechanics	July/Aug -2022
10	21EME25	Elements of Mechanical Engineering	July/Aug -2022
11	21EGH28	Professional Writing Skills in English	July/Aug-2022
12	21IDT29	Innovation and Design Thinking	July/Aug-2022
13	21SFH29	Scientific Foundations of Health	July/Aug-2022

# GBCS SCHEME

USN

--	--	--	--	--	--	--	--	--	--

21MAT11

## First Semester B.E. Degree Examination, July/August 2022 Calculus and Differential Equations

Time: 3 hrs.

Max. Marks: 100

Note: Answer any FIVE full questions, choosing ONE full question from each module.

### Module-1

- 1 a. With usual notation prove that  $\tan \phi = r \left( \frac{d\theta}{dr} \right)$ . (06 Marks)
- b. Find the angle between the curves  $r = 2 \sin \theta$  and  $r = 2 \cos \theta$ . (07 Marks)
- c. Find the radius of curvature of the curve  $\sqrt{x} + \sqrt{y} = \sqrt{a}$  at the point  $\left( \frac{a}{4}, \frac{a}{4} \right)$ . (07 Marks)

OR

- 2 a. With usual notation prove that  $\rho = \frac{(1 + y_1^2)^{\frac{3}{2}}}{y_2}$ . (06 Marks)
- b. Find the radius of curvature for the curve  $r^n = a^n \sin n \theta$ . (07 Marks)
- c. Show that  $r = 4 \sec^2 \theta/2$  and  $r = 9 \operatorname{cosec}^2 \theta/2$  the pair of curves cut orthogonally. (07 Marks)

### Module-2

- 3 a. Expand  $Y = \log(1 + \sin x)$  upto the term contains  $x^4$  by Maclaurin's series expansion. (06 Marks)
- b. If  $u = f(2x - 3y, 3y - 4z, 4z - 2x)$ , show that  $6u_x + 4u_y + 3u_z = 0$ . (07 Marks)
- c. Show that the function  $f(x, y) = x^3 + y^3 - 63x - 63y + 12xy$  is maximum at  $(-7, -7)$ . (07 Marks)

OR

- 4 a. Evaluate  $\lim_{x \rightarrow 0} (\cos x)^{\frac{1}{x^2}}$ . (06 Marks)
- b. If  $u = x^3 + y^3$  where  $x = a \cos t$ ,  $y = b \sin t$  find  $\frac{dU}{dt}$ . (07 Marks)
- c. If  $U = e^x \cos y$ ,  $V = e^x \sin y$ . Find  $\frac{\partial(u, v)}{\partial(x, y)}$ . (07 Marks)

**Module-3**

- 5 a. Solve for P :  $xp^2 + (y - x)p - y = 0$ ; where  $p = \frac{dy}{dx}$ . (06 Marks)
- b. Show that the family of parabolas  $y^2 = 4a(x + a)$  is self orthogonal. (07 Marks)
- c. Solve  $(x^2 + y^2 + x) dx + xy dy = 0$ . (07 Marks)

OR

- 6 a. Solve :  $[1 + \log x + \log y]dx + \left(1 + \frac{x}{y}\right)dy = 0$ . (06 Marks)
- b. Solve :  $p = \sin(y - xp)$ . Also find its singular solutions. (07 Marks)
- c. A body originally at  $80^\circ\text{C}$  cools down to  $60^\circ\text{C}$  in 20 minutes, the temperature of the air being  $40^\circ\text{C}$ . What will be the temperature of the body after 40 minutes from the original? (07 Marks)

**Module-4**

- 7 a. Solve :  $\frac{d^4y}{dx^4} - 4\frac{d^2y}{dx^2} + 4y = 0$ . (06 Marks)
- b. Solve :  $(D^2 + 4)y = e^x + \cos 2x$ . (07 Marks)
- c. Using Variation of parameter method, solve  
 $\frac{d^2y}{dx^2} - 2\frac{dy}{dx} = e^x \sin x$ . (07 Marks)

OR

- 8 a. Solve :  $(D^2 - 1)y = 1 + x + x^2$ . (06 Marks)
- b. Solve :  $(D^2 + D + 1)y = (1 - e^x)$ . (07 Marks)
- c. Solve :  $(1+x)^2 \frac{dy^2}{dx^2} + (1+x) \frac{dy}{dx} + y = 2 \sin[\log(1+x)]$ . (07 Marks)

Module-5

- 9 a. Find the rank of the matrix :

$$\begin{bmatrix} -1 & 2 & 3 & -2 \\ 2 & -5 & 1 & 2 \\ 3 & -8 & 5 & 2 \\ 5 & -12 & -1 & 6 \end{bmatrix}.$$

(06 Marks)

- b. Find for what values of  $\lambda$  and  $\mu$  the system of linear equations :

$$x + y + z = 6$$

$$x + 2y + 5z = 10$$

$$2x + 3y + \lambda z = \mu$$

has

- i) a unique solution  
 ii) no solution  
 iii) Infinitely many solutions.

(07 Marks)

- c. Solve the system of equations :

$$10x + 2y + z = 9$$

$$2x + 20y - 2z = -44$$

$$-2x + 3y + 10z = 22$$

by Gauss Seidel method taking  $(0, 0, 0)$  as an initial approximate root (carry out 3 iteration).

(07 Marks)

OR

- 10 a. Find the rank of the matrix :

$$\begin{bmatrix} 221 & 22 & 23 & 24 \\ 22 & 23 & 24 & 25 \\ 23 & 24 & 25 & 26 \\ 24 & 25 & 26 & 27 \end{bmatrix}.$$

(06 Marks)

- b. Solve the system of equations by Gauss – Jordan method,

$$x + y + z = 9$$

$$x - 2y + 3z = 8$$

$$2x + y - z = 3.$$

(07 Marks)

- c. Using Rayleigh power method find the largest eigen value and the corresponding eigen vector of the matrix

$$A = \begin{bmatrix} 6 & -2 & 2 \\ -2 & 3 & 1 \\ 2 & -1 & 3 \end{bmatrix}$$

by taking  $(1, 1, 1)^T$  as initial eigen vector (carryout 5 iterations).

(07 Marks)

\*\*\*\*\*

# GBCS SCHEME

USN

--	--	--	--	--	--	--	--	--	--

21PSP13/23

## First/Second Semester B.E. Degree Examination, July/August 2022 Problem Solving Through Programming

Time: 3 hrs.

Max. Marks: 100

*Note: Answer any FIVE full questions, choosing ONE full question from each module.*

### Module-1

- 1 a. Discuss various generations of computers, highlighting features of each one. (10 Marks)  
b. With the basic structure of a C program and explain with an example. (10 Marks)

OR

- 2 a. Differentiate primary memory and secondary memory. (05 Marks)  
b. List and explain logical operators and analyze the following code and write the output with proper reasoning.  
#include <stdio.h>  
void main( )  
{  
printf("7 && 0 = % d\n", 7 && 0);  
printf("7 || 0 = % d\n", 7 || 0);  
printf("!0 = %d", !0);  
}  
c. Discuss basic data types supported in 'C'. (05 Marks)

### Module-2

- 3 a. Write a C program to find roots of a quadratic equation. (10 Marks)  
b. Write the syntax of switch statement and explain with a suitable example. (10 Marks)

OR

- 4 a. Write the syntax of while and do-while statements. Also, list differences between them with example. (06 Marks)  
b. Write a C program to print whether a given integer number is palindrome or not. (07 Marks)  
c. Discuss break and continue statements with suitable examples. (07 Marks)

### Module-3

- 5 a. Define arrays and discuss various ways of initializing 1D array with examples. (10 Marks)  
b. Write a C program to sort given integers in ascending order and using selection sort and trace by taking 5 integers. (10 Marks)

OR

- 6 a. Define strings and explain how they are declared and initialized. (06 Marks)  
b. Write a C program to search for a given number in an array using binary search technique. (08 Marks)  
c. Explain any 6 string manipulation functions with example. (06 Marks)

**Module-4**

- 7 a. What is a user defined function? Discuss different categories of user defined functions with appropriate example for each. (10 Marks)  
b. Write a recursive function to find factorial of a number. (06 Marks)  
c. Discuss storage class specifiers. (04 Marks)

**OR**

- 8 a. Define recursion. Write a recursive program to find  $n^{\text{th}}$  Fibonacci number. (08 Marks)  
b. Write a program to find GCD and LCM of 2 numbers. (08 Marks)  
c. What are the advantages of writing user defined functions? (04 Marks)

**Module-5**

- 9 a. Differentiate structures and unions with syntax and example. (06 Marks)  
b. Write a C program to swap 2 numbers and use the same to explain advantage of call by reference method over call by value method. (09 Marks)  
c. List any 5 preprocessor directives in C. (05 Marks)

**OR**

- 10 a. Write a C program to add 2 complex numbers using structures. (06 Marks)  
b. Write a C program to compute sum, mean and standard deviation of all elements stored in an array using pointers. (10 Marks)  
c. What are pointers? Discuss pointer arithmetic with examples. (04 Marks)

\*\*\*\*\*

--	--	--	--	--	--	--	--	--	--

## Second Semester B.E. Degree Examination, July/August 2022 Advanced Calculus and Numerical Methods

Time: 3 hrs.

Max. Marks: 100

*Note: Answer any FIVE full questions, choosing ONE full question from each module.*

### Module-1

- 1 a. Evaluate  $\int_{-c}^c \int_{-b}^b \int_{-a}^a (x^2 + y^2 + z^2) dx dy dz$ . (06 Marks)
- b. Evaluate  $\int_0^{4a} \int_{\frac{x^2}{4a}}^{2\sqrt{ax}} xy dy dx$  by changing the order of integration. (07 Marks)
- c. Prove that  $\beta(m, n) = \frac{\Gamma(m)\Gamma(n)}{\Gamma(m+n)}$ . (07 Marks)

**OR**

- 2 a. Evaluate  $\int_0^\infty \int_0^\infty e^{-(x^2+y^2)} dx dy$  by changing to polar coordinates. (06 Marks)
- b. Find the area between the parabolas  $y^2 = 4ax$  and  $x^2 = 4ay$ . (07 Marks)
- c. Prove that  $\int_0^{\frac{\pi}{2}} \sqrt{\cot \theta} d\theta = \frac{\pi}{\sqrt{2}}$ . (07 Marks)

### Module-2

- 3 a. Find the directional derivative of  $\phi = \frac{xz}{x^2 + y^2}$  at the point (1, -1, 1) in the direction of  $\hat{i} - 2\hat{j} + \hat{k}$ . (06 Marks)
- b. Find  $\text{div } \vec{F}$  and  $\text{curl } \vec{F}$ , where  $\vec{F} = \text{grad}(xy^3z^3)$ . (07 Marks)
- c. If  $\vec{F} = (x + y + az)\hat{i} + (bx + 2y - z)\hat{j} + (x + cy + 2z)\hat{k}$ , find a, b, c such that  $\vec{F}$  is irrotational. (07 Marks)

**OR**

- 4 a. If  $\vec{F} = xy\hat{i} + (x^2 + y^2)\hat{j}$ , evaluate  $\int_C \vec{F} \cdot d\vec{r}$  along the curve  $C: y = x^2 - 4$  in the xy-plane from the point (2, 0) to (4, 12). (06 Marks)
- b. Using Green's theorem, evaluate  $\int (y - \sin x) dx + \cos x dy$  where C is the triangle in the xy-plane bounded by the lines  $y = 0$ ,  $x = \frac{\pi}{2}$  and  $y = \frac{2x}{\pi}$ . (07 Marks)
- c. Using Stokes theorem, evaluate  $\oint_C \vec{F} \cdot d\vec{r}$ , where  $\vec{F} = (x^2 + y^2)\hat{i} - 2xy\hat{j}$  taken around the rectangle bounded by  $x = 0$ ,  $x = a$ ,  $y = 0$ ,  $y = b$ . (07 Marks)



**Module-3**

- 5 a. Form the partial differential equation by eliminating the arbitrary function from  $z = f(x^2 + y^2)$  (06 Marks)
- b. Solve  $\frac{\partial^2 z}{\partial x^2} = a^2 z$  given that  $x = 0, z = 0$  and  $\frac{\partial z}{\partial x} = a \sin y$ . (07 Marks)
- c. Derive one dimensional wave equation,  $\frac{\partial^2 u}{\partial t^2} = C^2 \frac{\partial^2 u}{\partial x^2}$ . (07 Marks)

**OR**

- 6 a. Form the partial differential equation by eliminating the arbitrary function from,  $x+y+z = f(x^2+y^2+z^2)$  (06 Marks)
- b. Solve  $\frac{\partial^2 z}{\partial x \partial y} = \sin x \sin y$  for which  $\frac{\partial z}{\partial y} = -2 \sin y$ , when  $x = 0$  and  $z = 0$  when  $y$  is an odd multiple of  $\frac{\pi}{2}$ . (07 Marks)
- c. Solve  $(x + 2z)p + (4zx - y)q = (2x^2 + y)$  (07 Marks)

**Module-4**

- 7 a. Find a root of the equation  $\tan x = x$  which is near to  $x = 4.5$  using Newton's Raphson method. (06 Marks)
- b. Given  $\sin 45^\circ = 0.7071, \sin 50^\circ = 0.7660, \sin 55^\circ = 0.8192, \sin 60^\circ = 0.8660$  find  $\sin 52^\circ$  using Newton's forward interpolation formula. (07 Marks)
- c. Evaluate  $\int_0^1 \sqrt{\sin x + \cos x} dx$  correct to two decimal places using Simpson's  $\frac{1}{3}$  rule taking seven Equi distance ordinates. (07 Marks)

**OR**

- 8 a. Find the root of the equation  $x \log_{10} x = 1.2$  that lies between 2 and 3 correct to three decimal places, using Regula Falsi method. (06 Marks)
- b. Using Newton's divided difference formula find  $f(4)$  given that,
- |      |    |   |    |     |
|------|----|---|----|-----|
| x    | 0  | 2 | 3  | 6   |
| f(x) | -4 | 2 | 14 | 158 |
- (07 Marks)
- c. Evaluate  $\int_0^{0.3} \sqrt{1-8x^3} dx$  using Simpson's  $\left(\frac{3}{8}\right)^{\text{th}}$  rule by taking seven ordinates. (07 Marks)

**Module-5**

- 9 a. Solve  $\frac{dy}{dx} = e^x - y, y(0) = 2$  using Taylor's series method upto 4<sup>th</sup> degree terms at any point  $x$ . (06 Marks)
- b. Using modified Euler's method, find  $y$  at  $x = 0.2$  from  $\frac{dy}{dx} = 3x + \frac{y}{2}$  with  $y(0) = 1$  taking  $h = 0.1$  perform two iteration at each step. (07 Marks)
- c. Solve  $\frac{dy}{dx} = 2e^x - y$  given that  $y(0) = 2, y(0.1) = 2.010, y(0.2) = 2.040, y(0.3) = 2.090$  find  $y(0.4)$  using Milne's predictor corrector method. (07 Marks)

OR

- 10 a. Employ Taylor's series method to obtain the value of  $y$  at  $x = 0.1$  for the equation  $\frac{dy}{dx} = 2y + 3e^x$ ,  $y(0) = 0$  considering upto 4<sup>th</sup> degree term. (06 Marks)
- b. Use Runge Kutta method of order 4 find  $y$  at  $x = 0.2$  given that  $\frac{dy}{dx} = \frac{y^2 - x^2}{y^2 + x^2}$ ,  $y(0) = 1$  taking  $h = 0.2$ . (07 Marks)
- c. Apply Milne's predictor corrector method to find  $y(1.4)$  from  $\frac{dy}{dx} = x^2 + \frac{y}{2}$  given that  $y(1) = 2$ ,  $y(1.1) = 2.2156$ ,  $y(1.2) = 2.4549$ ,  $y(1.3) = 2.7514$ . (07 Marks)

\*\*\*\*\*

# CBCS SCHEME

USN

--	--	--	--	--	--	--	--	--	--

21CHE12/22

## First/Second Semester B.E. Degree Examination, July/August 2022 Engineering Chemistry

Time: 3 hrs.

Max. Marks: 100

**Note: Answer any FIVE full questions, choosing ONE full question from each module.**

### Module-1

- Define Single Electrode Potential. Derive Nernst equation for Single Electrode Potential. (07 Marks)
  - Explain the construction and working of glass electrode. (07 Marks)
  - Describe the construction and working of lithium ion battery. Mention its applications. (06 Marks)

OR

- What are Reference Electrodes? Discuss the construction and working of Calomel electrode. (07 Marks)
  - Calculate the single electrode potential of copper electrode at 28°C. Given that standard electrode potential of Cu is 0.34V and concentration of  $\text{Cu}^{2+}$  ions is 0.012m. (07 Marks)
  - Distinguish between Primary, Secondary and Reserve batteries. (06 Marks)

### Module-2

- Explain the following factors which affect the rate of corrosion :
    - Ratio of Anodic and Cathodic area
    - Nature of corrosion product.(07 Marks)
  - What is Electroless Plating? Distinguish between Electroplating and Electroless plating. (07 Marks)
  - Describe differential Metal corrosion and Water line corrosion. (06 Marks)

OR

- Explain Sacrificial anode and Impressed current method of corrosion control. (07 Marks)
  - What is meant by Metal finishing? Mention technological importance of Metal finishing. (07 Marks)
  - A steel sheet area  $400\text{cm}^2$  ( $62\text{ in}^2$ ) is exposed to moist air. After one year period it was found to experience a weight loss of 375g due to corrosion. If the density of steel is  $7.9\text{ g/cm}^3$ , calculate the CPR in mpy and  $\text{mmy}^{-1}$ . Given that  $K = 534$  in mpy and  $87.6$  in  $\text{mmy}^{-1}$ . (06 Marks)

### Module-3

- What are Polymer Composites? Explain the synthesis, properties and applications of Kevlar. (07 Marks)
  - Describe the mechanism of conduction in Polyaniline. (07 Marks)
  - Discuss the properties and applications of Carbon nanotubes. (06 Marks)

OR

- Explain the synthesis, properties and application of Polymethane. (07 Marks)
  - What are Biodegradable polymers? Explain the synthesis, properties and applications of Polylactic acid. (07 Marks)
  - What are Nanomaterials? Describe the synthesis of Nano materials by Sol – Gel process. (06 Marks)

**Module-4**

- 7 a. Define Green chemistry. Briefly explain basic principles of Green chemistry. (07 Marks)  
b. Discuss the synthesis of Adipic acid by conventional route from benzene and green route from glucose. (07 Marks)  
c. Describe the construction and working of Methanol – Oxygen fuel cell. (06 Marks)

**OR**

- 8 a. Explain the synthesis of Paracetamol by conventional and green route from phenol. (07 Marks)  
b. Describe the production of hydrogen by photocatalytic water Splitting method. (07 Marks)  
c. Explain the construction and working of Photovoltaic cell. (06 Marks)

**Module-5**

- 9 a. Explain the Theory , Instrumentation and Applications of Colorimetry. (07 Marks)  
b. Discuss the determination of hardness of water by EDTA method. (07 Marks)  
c. Define the following terms :  
i) Normality      ii) Molarity      iii) Mole fraction. (06 Marks)

**OR**

- 10 a. Explain the theory and any two applications of Conductometric Analysis. (07 Marks)  
b. In a COD experiment, 24.8 and 16.6cm<sup>3</sup> of 0.2N FAS solutions are required for blank and sample titration respectively. The volume of test sample used was 25cm<sup>3</sup>. Calculate COD of the sample solution. (07 Marks)  
c. What are Primary and Secondary standards? Explain the requirements of Primary Standard solution. (06 Marks)

\* \* \* \* \*

# GBCS SCHEME

USN

--	--	--	--	--	--	--	--	--	--

21PHY12/22

## First/Second Semester B.E. Degree Examination, July/August 2022 Engineering Physics

Time: 3 hrs.

Max. Marks: 100

*Note: 1. Answer any FIVE full questions, choosing ONE full question from each module.*

*2. Draw neat sketches wherever necessary.*

*3. Constants : Electron mass  $M = 9.1 \times 10^{-31}$  kg, Electron charge  $e = 1.6 \times 10^{-19}$  C,  
Velocity of light  $C = 3 \times 10^8$  m/s, Planck's constant  $h = 6.626 \times 10^{-34}$  Js,  
Avagadro number  $N_A = 6.025 \times 10^{26}$  /k mol,  
Permittivity of free space  $\epsilon_0 = 8.854 \times 10^{-12}$  F/m,  
Acceleration due to gravity  $g = 9.8$  m/s<sup>2</sup>, Boltzman constant  $K = 1.38 \times 10^{-23}$  J/K*

### Module-1

- 1 a. What are forced oscillations? Obtain expression for displacement of forced oscillations. (08 Marks)
- b. With a neat diagram explain the construction and working of Reddy's shock tube. (08 Marks)
- c. For a particle executing simple harmonic motion amplitude is 13m and period is  $2\pi$  sec. Find its velocity when the displacement is 5m from the mean position. (04 Marks)

OR

- 2 a. Find the effective spring constant in case of spring connected in series and parallel combination. (08 Marks)
- b. Define SHM and mention any two examples. Obtain differential equation of motion for SHM and its natural frequency of oscillation. (08 Marks)
- c. A mass of 2 kg suspended by a spring of force constant 51.26 N/m is executing damped SHM with a damping 5 kg/s. Identify whether it is the case of underdamping or of overdamping. Also estimate the value of damping required for the oscillation to be critically damped (Ignore the mass of spring) (04 Marks)

### Module-2

- 3 a. Using Schrodinger wave equation, obtain the eigen function and eigen value for a particle in a box. (09 Marks)
- b. State Heisenberg Uncertainty Principle. Show that an electron does not exist inside the nucleus on the basis of Heisenberg Uncertainty Principle. (07 Marks)
- c. Calculate the energy of the neutron in eV, if its deBroglie wavelength is  $3 \text{ \AA}$  and  $m_n = 1.67 \times 10^{-27}$  kg. (04 Marks)

OR

- 4 a. Discuss the spectral radiancy in Black body? Deduce Wein's law and Rayleigh-Jean's law from Planck's radiation law. (09 Marks)
- b. Setup one-dimensional time-independent Schrodinger wave equation. (07 Marks)
- c. An electron is bound in a 1-dimensional box of 0.1 nm length. Calculate the energy required to excite it from its ground state to third excited state. (04 Marks)

**Module-3**

- 5 a. Explain the requisites for a laser action? Obtain the expression for energy density using Einstein's coefficients at thermal equilibrium condition. (10 Marks)
- b. With neat diagram explain the principle, construction and working of phase modulated temperature sensor. (06 Marks)
- c. How many photons of yellow light of wavelength  $5500 \text{ \AA}$  constitutes 1.5 J of energy. (04 Marks)

**OR**

- 6 a. Explain the construction and working of carbon dioxide laser with the help of energy level diagram. (09 Marks)
- b. What is numerical aperture? Derive the expression for acceptance angle of an optical fiber. (07 Marks)
- c. Calculate the refractive indices of core and cladding of a given optical fiber with numerical aperture of 0.22 and fractional index change variation 0.012. (04 Marks)

**Module-4**

- 7 a. Mention any three assumptions of classical free electron theory? Discuss the success of Quantum free electron theory. (09 Marks)
- b. Obtain expression for electrical conductivity in semiconductors. (07 Marks)
- c. The dielectric constant of He gas at NTP is 1.0000684. Calculate the electronic polarisability of He atoms if the gas contains  $2.7 \times 10^{28}$  atom/m<sup>3</sup>. (04 Marks)

**OR**

- 8 a. What is Hall Effect? Obtain expression for Hall voltage and express Hall voltage in terms of Hall coefficient. (09 Marks)
- b. What is polarization? Explain different types of polarization. (07 Marks)
- c. Find the temperature at which there is 1% probability that a state with an energy 0.5 eV above Fermi energy is occupied. (04 Marks)

**Module-5**

- 9 a. With a neat diagram, explain the principle, construction and working of Atomic Force Microscope. (10 Marks)
- b. What are nano-materials and classify the nano materials based on the dimensional constraints. (05 Marks)
- c. GaAs has its principle planes separated at  $5.6534 \text{ \AA}$ . The first order Bragg reflection is located at  $13^\circ 40'$ . Calculate  
(i) The wavelength of the x-ray  
(ii) The angle for second order Bragg reflection. (05 Marks)

**OR**

- 10 a. Explain the construction and working of x-ray diffractometer. (07 Marks)
- b. Describe the principle, construction and working of scanning electron microscope with the help of neat diagram. (08 Marks)
- c. Determine the crystal size given the wavelength of x-ray 12 nm, the peak width  $0.5^\circ$  and peak position  $23^\circ$  for a cubic crystal. Given  $K = 0.94$ . (05 Marks)

\* \* \* \* \*

# GBCS SCHEME

USN

--	--	--	--	--	--	--	--	--	--

21ELE13/23

## First/ Second Semester B.E. Degree Examination, July/August 2022 Basic Electrical Engineering

Time: 3 hrs.

Max. Marks: 100

*Note: Answer any FIVE full questions, choosing ONE full question from each module.*

### Module-1

- 1 a. State and explain ohm's law with its limitations. (06 Marks)
- b. Define form factor. Obtain its value for a sinusoidal voltage. (08 Marks)
- c. A circuit consists of two parallel resistors of  $20\ \Omega$  and  $30\ \Omega$  respectively, connected in series with a  $15\ \Omega$  resistor. If the current through  $15\ \Omega$  resistor is  $3\text{A}$ , find the branch currents, supply voltage and power consumed by  $20\ \Omega$  and  $15\ \Omega$  resistors. (06 Marks)

OR

- 2 a. Prove that, the circuit efficiency during maximum power transfer from source to load is only 50%. (06 Marks)
- b. Show that, the power consumed by a pure capacitor is zero, when connected across A.C. supply. (08 Marks)
- c. For the sine wave,  $e = 140\sin 314t$ . Find:
  - (i) Peak value
  - (ii) Frequency
  - (iii) Average value
  - (iv) RMS value
  - (v) Time period
  - (vi) Instantaneous voltage at  $t = 3\text{ ms}$(06 Marks)

### Module-2

- 3 a. Develop an equation for the power consumed by a R-L series circuit. Draw the waveform of voltage, current and power. (08 Marks)
- b. Deduce the relationship between the line and phase values of voltage and current of a three phase star connected system. (06 Marks)
- c. Two impedances  $Z_1 = (150 - j157)\ \Omega$  and  $Z_2 = (100 - j110)\ \Omega$  are connected in parallel across  $200\text{ V}$ ,  $50\text{ Hz}$  supply. Find:
  - (i) Total current
  - (ii) Branch currents
  - (iii) Total power consumed
  - (iv) Draw phasor diagram(06 Marks)

OR

- 4 a. Show that, only two wattmeters are sufficient to measure power in a three phase balanced star connected circuit with the help of neat circuit diagram and phasor diagram. (08 Marks)
- b. A balanced star connected load of  $(8 + j6)\ \Omega$  per phase is connected to a 3-phase,  $230\text{ V}$  supply. Find the line current, power factor, active power, reactive power and total power. (06 Marks)
- c. A circuit consists of a resistance of  $25\ \Omega$  and a capacitance of  $100\ \mu\text{F}$  connected in series. A supply of  $200\text{ V}$ ,  $50\text{ Hz}$  is applied across the circuit. Find:
  - (i) Impedance
  - (ii) Current
  - (iii) Power factor
  - (iv) Power
  - (v) Voltage drop across R and C
  - (vi) Draw phasor diagram.(06 Marks)

**Module-3**

- 5 a. With the help of neat diagram, explain the construction of D.C. generator. (08 Marks)  
 b. With usual notations, derive the emf equation of a transformer. (06 Marks)  
 c. The field current in a d.c. shunt machine is 2A and the line current is 20A at 200V. Calculate:  
 (i) The generated emf when working as generator  
 (ii) Torque (N-m) when running at 1500 rpm as motor  
 Take the armature resistance as  $0.5 \Omega$ . (06 Marks)

**OR**

- 6 a. Explain the losses in a transformer and how to minimize them. On what factor they depend? Give the equations for these losses. (08 Marks)  
 b. With usual notations, derive the torque equation of a D.C. motor. (06 Marks)  
 c. A transformer is rated at 100 KVA. At full load its copper loss is 1200 Watts and its iron loss is 960 Watts. Calculate:  
 (i) The efficiency at full load, UPf  
 (ii) The efficiency at half load, 0.8 p.f.  
 (iii) The maximum efficiency at 0.85 p.f. for the new load KVA 89 KVA at which maximum efficiency occurs. (06 Marks)

**Module-4**

- 7 a. With relevant diagram, explain the construction of three phase induction motor. (08 Marks)  
 b. Explain the advantages of rotating magnetic field over the rotating armature in a synchronous generator. (06 Marks)  
 c. A 10 pole induction motor supplied by a 6 pole alternator which is driven at 1200 rpm. If the motor runs at a slip of 3%, what is its speed and frequency of rotor induced emf. (06 Marks)

**OR**

- 8 a. Derive an emf equation of a synchronous generator. Explain the significance of winding factor. (08 Marks)  
 b. Define slip of a 3-phase induction motor and derive the relation between supply frequency and rotor current frequency. (06 Marks)  
 c. A 3-phase, 16 pole alternator has a star connected winding with 144 slots and 10 conductors per slot. The flux per pole is 0.003 webers and the speed is 375 rpm. Find the frequency, phase emf and line emf. (06 Marks)

**Module-5**

- 9 a. With a single line diagram, explain the power transmission and distribution. (06 Marks)  
 b. What is earthing? With a neat diagram, explain pipe earthing. (08 Marks)  
 c. Define tariff. Explain briefly the two part tariff with its advantages and disadvantages. (06 Marks)

**OR**

- 10 a. What is electric shock? Give the list of preventive measures against the shock. (06 Marks)  
 b. With neat diagram, explain the working of fuse and RCCB (Residual Current Circuit Breaker). (08 Marks)  
 c. A consumer has a maximum demand of 200 KW at 40% load factor. If the tariff is Rs.100 per KW of maximum demand plus 10 paise per KWh. Find the overall cost per KWh. (06 Marks)

\*\*\*\*\*



# GBCS SCHEME

USN

--	--	--	--	--	--	--	--	--	--

21PSP13/23

## First/Second Semester B.E. Degree Examination, July/August 2022 Problem Solving Through Programming

Time: 3 hrs.

Max. Marks: 100

*Note: Answer any FIVE full questions, choosing ONE full question from each module.*

### Module-1

- 1 a. Discuss various generations of computers, highlighting features of each one. (10 Marks)
- b. With the basic structure of a C program and explain with an example. (10 Marks)

OR

- 2 a. Differentiate primary memory and secondary memory. (05 Marks)
- b. List and explain logical operators and analyze the following code and write the output with proper reasoning.  
#include <stdio.h>  
void main( )  
{  
printf("7 && 0 = % d\n", 7 && 0);  
printf("7 || 0 = % d\n", 7 || 0);  
printf("!0 = %d", !0);  
}
- c. Discuss basic data types supported in 'C'. (05 Marks)

### Module-2

- 3 a. Write a C program to find roots of a quadratic equation. (10 Marks)
- b. Write the syntax of switch statement and explain with a suitable example. (10 Marks)

OR

- 4 a. Write the syntax of while and do-while statements. Also, list differences between them with example. (06 Marks)
- b. Write a C program to print whether a given integer number is palindrome or not. (07 Marks)
- c. Discuss break and continue statements with suitable examples. (07 Marks)

### Module-3

- 5 a. Define arrays and discuss various ways of initializing 1D array with examples. (10 Marks)
- b. Write a C program to sort given integers in ascending order and using selection sort and trace by taking 5 integers. (10 Marks)

OR

- 6 a. Define strings and explain how they are declared and initialized. (06 Marks)
- b. Write a C program to search for a given number in an array using binary search technique. (08 Marks)
- c. Explain any 6 string manipulation functions with example. (06 Marks)

**Module-4**

- 7 a. What is a user defined function? Discuss different categories of user defined functions with appropriate example for each. (10 Marks)  
b. Write a recursive function to find factorial of a number. (06 Marks)  
c. Discuss storage class specifiers. (04 Marks)

**OR**

- 8 a. Define recursion. Write a recursive program to find  $n^{\text{th}}$  Fibonacci number. (08 Marks)  
b. Write a program to find GCD and LCM of 2 numbers. (08 Marks)  
c. What are the advantages of writing user defined functions? (04 Marks)

**Module-5**

- 9 a. Differentiate structures and unions with syntax and example. (06 Marks)  
b. Write a C program to swap 2 numbers and use the same to explain advantage of call by reference method over call by value method. (09 Marks)  
c. List any 5 preprocessor directives in C. (05 Marks)

**OR**

- 10 a. Write a C program to add 2 complex numbers using structures. (06 Marks)  
b. Write a C program to compute sum, mean and standard deviation of all elements stored in an array using pointers. (10 Marks)  
c. What are pointers? Discuss pointer arithmetic with examples. (04 Marks)

\*\*\*\*\*

--	--	--	--	--	--	--	--	--	--

## First/Second Semester B.E. Degree Examination, July/August 2022 Elements of Civil Engineering and Mechanics

Time: 3 hrs.

Max. Marks: 100

*Note: Answer any FIVE full questions, choosing ONE full question from each module.*

### Module-1

- 1 a. Briefly enumerate the scope of following specialization/branches of civil engineering:
  - i) Structural Engineering
  - ii) Transportation Engineering. (10 Marks)
- b. Discuss the role of civil engineer in infrastructure development of a country. (05 Marks)
- c. Mention the properties and uses of aluminium in construction industry. (05 Marks)

OR

- 2 a. Enlist the qualities of good building stone. (06 Marks)
- b. What is glass? List its importance and application. (06 Marks)
- c. Discuss the importance and application of smart materials in construction. (08 Marks)

### Module-2

- 3 a. Explain 'Principle of Transmissibility' with a neat sketch. (04 Marks)
- b. Determine the resultant of four concurrent force system acting on a particle as shown in Fig.Q.3(b). (08 Marks)

Fig.Q.3(b)

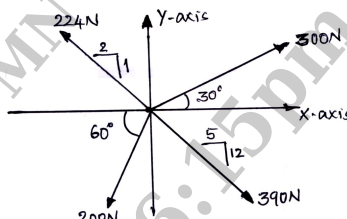

- c. The Fig.Q.3(c) shows a system of cables in equilibrium under two vertical loads of 300N and 500N acting at points B and C respectively. Determine the forces developed in all the cables. (08 Marks)

Fig.Q.3(c)

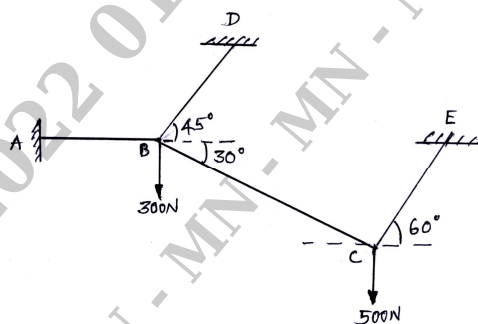

OR

- 4 a. Determine the magnitude, direction and position of the resultant of the force system shown in Fig.Q.4(a). (10 Marks)

Fig.Q.4(a)

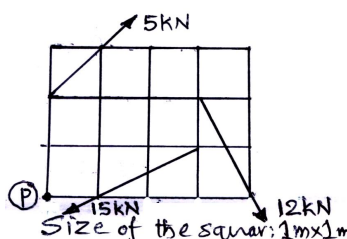

- b. A block of mass 20kg placed on an inclined plane as shown in Fig.Q.4(b) is subjected to a force P acting parallel to the plane. The plane is inclined at an angle  $30^\circ$  to the horizontal with coefficient of friction being 0.24. determine the magnitude of P for
- Motion of the body impending down the plane.
  - Motion of the body impending up the plane.

(10 Marks)

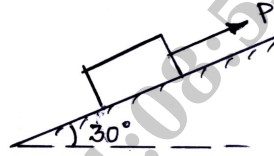

Fig.Q.4(b)

**Module-3**

- 5 a. Define the following:
- Centroid
  - Axis of symmetry.
- b. Find the position of centroid of the given area shown in Fig.Q.5(b) with respect to reference axis. All dimensions are in m.

(02 Marks)

(08 Marks)

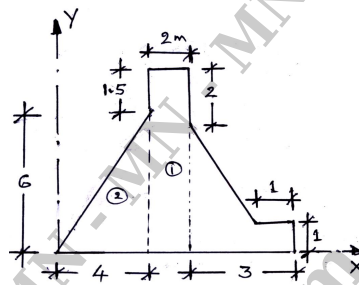

Fig.Q.5(b)

- c. Find the polar radius of gyration of the given area shown in Fig.Q.5(c) with respect to its centroidal axis. All dimensions are in mm.

(10 Marks)

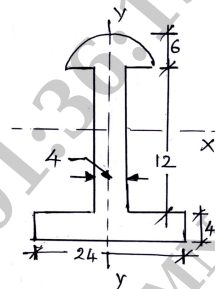

Fig.Q.5(c)

**OR**

- 6 a. State and prove parallel axis theorem. (04 Marks)
- b. Find the moment of inertia of a rectangular area with respect to its centroidal axis from first principles/method of integration. (06 Marks)
- c. Locate the centroid of the shaded area shown in Fig.Q.6(c) with respect to the X and Y axis. (10 Marks)

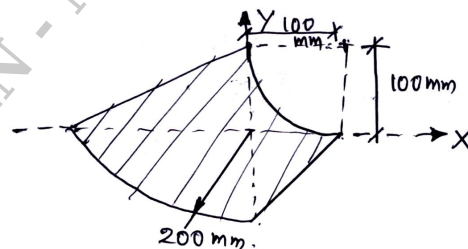

Fig.Q.6(c)

**Module-4**

- 7 a. Differentiate between 'determinate and indeterminate' structure with an example for each. (06 Marks)
- b. Explain the different types of beams and supports. (06 Marks)
- c. Determine reactions at A and E for the beam shown in Fig.Q.7(c). (08 Marks)

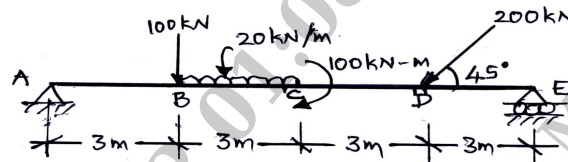

Fig.Q.7(c)

**OR**

- 8 a. List the assumptions made in the analysis of truss. (04 Marks)
- b. Explain different types of loads. (03 Marks)
- c. Determine the magnitude and nature of forces in the members of the truss shown in Fig.Q.8(c) by method of joints. (13 Marks)

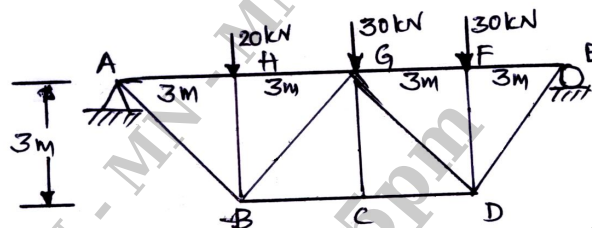

Fig.Q.8(c)

**Module-5**

- 9 a. What is Super elevation? Why it is required? (04 Marks)
- b. Two cars P and Q accelerates from a standing start. The acceleration of P is  $1.3\text{m/s}^2$  and that of Q is  $1.6\text{m/s}^2$ . If Q starts initially 6m behind P, how long it takes to overtake P? (08 Marks)
- c. A stone 'A' is dropped from a tower of 50m height. At the same height, another stone B is thrown up from the front of the tower with velocity of 25m/s. At what distance from top and after how much time the two stones will cross each other. (08 Marks)

**OR**

- 10 a. State D' Alembert's principle. Mention its application for the case of plane motion. (04 Marks)
- b. Two stones A and B are projected from the same point at an inclination of  $45^\circ$  and  $30^\circ$  respectively to the horizontal. Find the ratio of velocities of projection of A and B, if the maximum height reached by them is same. (08 Marks)
- c. A pilot flying his bomber at a height of 2000m with uniform horizontal velocity of 600kmph wants to strike a target. At what distance from the target he should release the bomb. (08 Marks)

\* \* \* \* \*

# GBCS SCHEME

USN

--	--	--	--	--	--	--	--	--	--

21ELN14/24

## First/Second Semester B.E. Degree Examination, July/August 2022 Basic Electronics and Communication Engineering

Time: 3 hrs.

Max. Marks: 100

*Note: Answer any FIVE full questions, choosing ONE full question from each module.*

### Module-1

- 1 a. With a neat block diagram, explain the working of DC power supply. Also mention the principle components used in each block. (07 Marks)
- b. Sketch the circuit of each of the following based on the use of operational amplifiers:  
(i) Differentiator (ii) Integrator (iii) Inverting amplifier (06 Marks)
- c. Explain the working of Bi phase Full wave rectifier circuit with neat diagram and waveforms. (07 Marks)

OR

- 2 a. Mention the advantages of negative feed-back in amplifiers circuits. With relevant equations and diagram, explain the concept of negative feedback. (07 Marks)
- b. With suitable circuit diagram, explain single stage astable multivibrator using operational amplifier. (07 Marks)
- c. Explain the conditions for sustained oscillations. Determine the frequency of oscillation of a three stage ladder network in which  $C = 10 \text{ nF}$  and  $R = 10 \text{ K}\Omega$ . (06 Marks)

### Module-2

- 3 a. With a neat block diagram, explain the arrangement of a microcontroller system. (06 Marks)
- b. Design a 3:8 decoder and show its implementation using basic gates. (08 Marks)
- c. With the help of truth table, explain a full adder using logic gates. (06 Marks)

OR

- 4 a. Write a note on different data types mentioning the bit size and range of values supported. (06 Marks)
- b. Define a bistable. Using truth table and logic circuit, explain RS bistable. (07 Marks)
- c. What is multiplexer? With truth table and logic circuit, explain 8:1 multiplexer. (07 Marks)

### Module-3

- 5 a. Compare embedded system and general computing system. Also provide the application areas of embedded systems. (08 Marks)
- b. Explain the different configurations of 7-segment LED display. (06 Marks)
- c. Write a note on classification of embedded systems. (06 Marks)

OR

- 6 a. Define actuator. With relevant diagram, explain the operation of Relay, Push button, Piezo buzzer. (08 Marks)
- b. Bring out the differences between RISC and CISC and Harvard and Vonneumann architecture. (06 Marks)
- c. Bring out the main features of UART and USB. (06 Marks)

**Module-4**

- 7 a. Describe the basic block diagram of a communication system. (06 Marks)  
b. Explain the following with the help of waveforms: (i) PAM (ii) PWM (iii) PPM (08 Marks)  
c. Define an antenna and discuss different types of antennas. (06 Marks)

**OR**

- 8 a. Explain different types of radio wave propagation with a neat diagram. (06 Marks)  
b. Discuss various Multiple Access Techniques used in cellular network. (06 Marks)  
c. Define sampling theorem, Nyquist rate and explain when aliasing can happen. Also mention the ways in which aliasing can be avoided. (08 Marks)

**Module-5**

- 9 a. Draw the schematic diagram of a cellular telephone system and define its basic components. (06 Marks)  
b. Bring out the features of FM transmitter and FM receiver in microwave communication system. (08 Marks)  
c. Explain the optical fibre communication system with a block diagram. (06 Marks)

**OR**

- 10 a. Write a short note on : (i) WLAN (ii) Blue tooth (06 Marks)  
b. Draw the architecture of GSM system and explain the important features of it. (08 Marks)  
c. Draw the block diagram showing the basic elements of a satellite communication system and briefly explain them. (06 Marks)

\* \* \* \* \*

# CBCS SCHEME

USN

--	--	--	--	--	--	--	--	--	--

21EME15/25

## First/Second Semester B.E. Degree Examination, July/August 2022 Elements of Mechanical Engineering

Time: 3 hrs.

Max. Marks: 100

Note: 1. Answer any FIVE full questions, choosing ONE full question from each module.  
2. Use of steam tables is permitted.

### Module-1

- 1 a. Discuss the various emerging trends and technologies in different sectors and their contribution to GDP. (06 Marks)
- b. Draw T-h diagram of steam formation and label the various properties of steam on it. (06 Marks)
- c. Describe the energy conversion from hydel energy into electrical energy with the aid of suitable sketch. (08 Marks)

OR

- 2 a. Explain the working of centrifugal pump with a sketch. (08 Marks)
- b. Find the enthalpy of one kg of steam at 12 bar when
  - i) Steam is 22% wet
  - ii) Steam is dry saturated
  - iii) Superheated to 250°CAssume specific heat of super heated steam as 2.25 kJ/kg K. the values of steam properties at 12 bar are  $t_s = 188^\circ\text{C}$ ,  $h_f = 798.43$  kJ/kg,  $h_g = 1984.3$  kJ/kg. (06 Marks)
- c. Briefly explain the working of tidal power plant and mention its limitations. (06 Marks)

### Module-2

- 3 a. Explain the non ferrous metals with their applications. (06 Marks)
- b. Distinguish between Soldering, Brazing and Welding. (06 Marks)
- c. Compare TIG and MIG welding with sketches. (08 Marks)

OR

- 4 a. Why is cooling necessary for electronic devices? Discuss Active, Passive and Hybrid cooling. (06 Marks)
- b. How are composites classified? Mention their applications. (06 Marks)
- c. What are smart materials and shape memory alloys? Explain. (08 Marks)

### Module-3

- 5 a. Draw a neat sketch of internal combustion engine and label the components. (06 Marks)
- b. Explain the concept of electric vehicle with components. (08 Marks)
- c. List the desirable properties of good refrigerant. (06 Marks)

OR

- 6 a. Explain the working of window type air conditioning system with neat sketch. (10 Marks)
- b. The following observations were made during a test on a two stroke cycle oil engine. Bore = 200mm, stroke = 250mm, Speed = 350 rpm, Brake drum diameter = 1200mm, Net brake load = 450N, mean effective pressure = 2.8bar, oil consumption = 3.6 kg/hr, calorific value of oil = 41868 kJ/kg. Determine IP, BP mechanical efficiency, indicated thermal efficiency and brake thermal efficiency. (10 Marks)



**Module-4**

- 7 a. Illustrate with sketches differences between simple and compound gear train. (08 Marks)  
b. Find the length of an open belt driving two parallel shafts 2m apart, connected by two pulleys of 0.1m and 0.8m diameter. Also determine the additional length of belt required if cross belt drive is used. (08 Marks)  
c. Define the terms :  
i) Machine  
ii) Mechanism. (04 Marks)

**OR**

- 8 a. Classify and explain the types of robots configuration. (10 Marks)  
b. List and explain the types of Gears. (05 Marks)  
c. Mention the applications of Chains and Ropes. (05 Marks)

**Module-5**

- 9 a. Explain the following lathe operations with sketches.  
i) Facing  
ii) Taper turning  
iii) Knurling. (10 Marks)  
b. Describe the working of CNC system and mention its applications. (10 Marks)

**OR**

- 10 a. Define milling. Explain the working of horizontal spindle milling machine. (10 Marks)  
b. Explain the concept of open loop and closed loop system in mechatronics. (05 Marks)  
c. Discuss the concept of smart manufacturing. (05 Marks)

\*\*\*\*\*

USN

--	--	--	--	--	--	--	--	--	--

Question Paper Version : A

**Second Semester B.E./B.Tech./B.Arch/B.Planning Degree Examination,  
July/August 2022**

**Professional Writing Skills in English**

**(COMMON TO ALL BRANCHES)**

Time: 2 hrs.]

[Max. Marks: 100

**INSTRUCTIONS TO THE CANDIDATES**

1. Answer all the Hundred questions, each question carries **ONE mark**.
2. Use only **Black ball point pen** for writing / darkening the circles.
3. For each question, after selecting your answer, darken the appropriate circle corresponding to the same question number on the OMR sheet.
4. Darkening two circles for the same question makes the answer invalid.
5. **Damaging/overwriting, using whiteners** on the **OMR** sheets are strictly prohibited.

**General English Grammar: Select the correct option.**

1. Her thinking leans \_\_\_\_\_ democracy.  
a) with                      b) towards                      c) for                      d) None of these
2. He got too tired \_\_\_\_\_ over work.  
a) because of                      b) because off                      c) on                      d) for
3. \_\_\_\_\_ his principles, he has to be very careful.  
a) with regard of                      b) with regard on                      c) with regard to                      d) None of these
4. Building has been built \_\_\_\_\_ the new plan.  
a) accordance to                      b) in accordance with                      c) for                      d) about
5. He crossed the broken bridge \_\_\_\_\_ warning.  
a) in spite of                      b) in spite off                      c) on                      d) about
6. Which of these do not deal with precise information?  
a) Engineer                      b) Scientist                      c) Technician                      d) Fiction writer
7. In an office, an employee communicates horizontally with his \_\_\_\_\_.  
a) superiors                      b) subordinates                      c) colleagues                      d) assistant
8. An average length of sentence in a paragraph should be \_\_\_\_\_.  
a) 15 to 20 words                      b) 25 to 30 words                      c) 2 to 5 words                      d) 5 to 10 words

9. Which of these is not a feature of a paragraph?  
 a) Length                      b) Unity                      c) Incoherence                      d) Correctness
10. Which of these is not an important feature of a paragraph?  
 a) Length                      b) Breadth                      c) Unity                      d) Coherence
11. Resume is called curriculum vitae in \_\_\_\_\_  
 a) India                      b) France                      c) North America                      d) South America
12. Which of these letters are in response to an advertisement?  
 a) Solicited letters                      b) Unsolicited letters  
 c) Letters of enquiry                      d) Letters of complaint
13. Which of these letters of application must include a statement of the writer's age?  
 a) For complain                      b) For employment                      c) For enquiry                      d) For adjustment
14. Technical writing demands \_\_\_\_\_ use of language.  
 a) figurative                      b) poetic                      c) factual                      d) dramatic
15. Which of these must be avoided in technical writing?  
 a) Facts                      b) Grammar  
 c) Punctuation                      d) Personal feelings
16. Which of these words is used in technical writing?  
 a) Apex                      b) Top                      c) Slanting                      d) Bottom
17. Which of these is a technical word for slanting?  
 a) Lateral                      b) Sloping                      c) Tilting                      d) Bent
18. Which of these should be avoided for an effective speech?  
 a) Planning of speech                      b) Preparation of speech  
 c) Long sentences                      d) Organization
19. Which of these should be avoided during the delivery of a speech?  
 a) Confidence                      b) Clarity                      c) Pauses                      d) Rudeness
20. Which of these is not a type of public speech?  
 a) Short speech                      b) Informal speech  
 c) Written speech                      d) Professional speech

#### General English Questions on Pronoun Correction:

21. Correct the sentence if necessary. One should respect his elders.  
 a) One should respect his elders.                      b) One should respect her elders.  
 c) One should respect one's elders.                      d) None of these.
22. Correct the sentence if necessary. One should respect his own country.  
 a) One should respect his own country.                      b) One should respect her own country.  
 c) One should respect their own country.                      d) One should respect one's country.



35. My sister is elder than me.  
 a) My sister is elder than me. b) My sister is elder to me.  
 c) My sister is elder then me. d) None of these.

**Questions on Verb Correction:**

36. Correct the sentence if necessary. The girl is taking biscuits every day.  
 a) The girl is taking biscuits every day. b) The girl takes biscuits every day.  
 c) The girls is taken biscuits every day. d) None of these.
37. Correct the sentence if necessary. He takes milk every day.  
 a) He takes milk every day. b) He is taking milk every day.  
 c) He is taken milk every day. d) None of these.
38. Correct the sentence if necessary. They are coming here regularly.  
 a) They are coming here regularly. b) They are come here regularly.  
 c) They come here regularly. d) None of these
39. I am studying every morning from 5-8 A.M.  
 a) I am studying every morning from 5-8 A.M.  
 b) I have been studying every morning from 5-8 A.M.  
 c) I study every morning from 5-8 A.M.  
 d) None of these.
40. Every evening, he is going for a walk.  
 a) Every evening, he is going for a walk.  
 b) Every evening, he goes for a walk.  
 c) Every evening, he has been going for a walk.  
 d) None of these.
41. A writer must not convey information with \_\_\_\_\_.  
 a) precision b) clarity c) randomness d) truth
42. Which of these are to be avoided in any style of writing?  
 a) Truth b) Clarity c) Compassion d) Dishonesty
43. Which of these reports are used in business?  
 a) Formal technical reports b) Informal reports  
 c) Personal reports d) Musical reports
44. Which of the following is NOT a method of writing a non-formal letter?  
 a) Filling in a blank form b) Form of a letter  
 c) Form of a memorandum d) Formal of a notice
45. A non-formal report written in the form of letter is similar to a \_\_\_\_\_.  
 a) friendly letter b) business letter c) complaint letter d) notice
46. Which of these does not come under reports?  
 a) News items b) Memorandums c) Notice d) Report cards

47. Which of these is not a parameter of a formal report?  
 a) Presentation      b) Complaint      c) Information      d) Request
48. Meaning of "Fly by night"  
 a) Night journey      b) A bird busy in night  
 c) Cat's eye      d) Swindler
49. Synonym of Exhort  
 a) Weak Plea      b) To urge strongly      c) Beg      d) Borrow
50. Antonym of Blunt  
 a) Easy      b) Lazy      c) Sharp      d) Speedy
51. Antonym of Brave  
 a) Achieve      b) Gain      c) Give      d) Cowardly
52. Synonym of Abjure  
 a) To give      b) To take back      c) Happy      d) Sorry
53. Synonym of Abrogate  
 a) Create      b) Run      c) Fascinate      d) Abolish
54. Unfortunately, he \_\_\_\_\_ a lot of money to the bank.  
 a) Borrowed      b) Owed      c) Deposited      d) Lent
55. I \_\_\_\_\_ the apartment all day yesterday.  
 a) Clear      b) Washed out      c) Cleaned up      d) None of these
56. The train \_\_\_\_\_ as fast as the bus.  
 a) went      b) running      c) moves      d) going
57. He was seen \_\_\_\_\_ to the school.  
 a) went      b) going      c) gone      d) go
58. She \_\_\_\_\_ in the sun for 1 hour  
 a) sitting      b) has been sitting      c) has been sit      d) has sit
59. \_\_\_\_\_ it help you in your studies?  
 a) will      b) was      c) is      d) are
60. I \_\_\_\_\_ never seen such a picture before  
 a) did      b) was      c) have      d) has
61. Words of same sound is?  
 a) Soundnyms      b) Antonyms      c) Homonyms      d) None of these
62. Sounding the same but spelt differently?  
 a) Symphonious      b) Homophonous      c) Synonyms      d) Saminymous

63. Choose the correct answer?  
 a) My friend has got a new job  
 b) My friend has got a new work  
 c) My friend is got a new job  
 d) My friend did got a new job
64. Choose the correct sentence.  
 a) Do you like a glass of water?  
 b) Would you like a glass of water?  
 c) Would you like the glass of water?  
 d) Do you like the glass of water?
65. Antonym of Ad-lib?  
 a) Improvise  
 b) Extemporized  
 c) Deliberate  
 d) Spontaneous
66. We \_\_\_\_\_ at the party.  
 a) Enjoyed ourself  
 b) Enjoyed ourselves  
 c) Played with  
 d) None of these
67. Choose a correct sentence below :  
 a) There are seven girls in the class.  
 b) There is seven girls in the class.  
 c) There are seven girl in the class.  
 d) There is seven girl in the class.
68. I \_\_\_\_\_ a letter to the Principal yesterday  
 a) write  
 b) forward  
 c) mailed  
 d) have signed
69. Choose the correct statement :  
 a) Although he was hurt, but he continued to walk.  
 b) Although he was hurt, he continued to walk.  
 c) He was hurt, he continued to walk.  
 d) Although he continued to walk, he was hurt.
70. Choose the correct statement :  
 a) There were between 8 to 10 policemen present.  
 b) There were between 8 and 10 policemen present.  
 c) There were among 8 to 10 policemen present.  
 d) There were atleast 8 and 10 policemen present.
71. Meaning of See Eye to Eye  
 a) To agree fully  
 b) Not agreeing fully  
 c) In a battle field  
 d) Angry
72. He \_\_\_\_\_ a very good grade in the examination  
 a) Earned  
 b) Given  
 c) Received  
 d) None of these
73. We \_\_\_\_\_ at the party late  
 a) arrived  
 b) went  
 c) played  
 d) saw
74. The patient \_\_\_\_\_ in his sleep  
 a) Woke up  
 b) Died  
 c) Cried off  
 d) None of these
75. I was delighted \_\_\_\_\_ her answer.  
 a) On  
 b) At  
 c) For  
 d) In
76. I have no doubt \_\_\_\_\_ it.  
 a) At  
 b) On  
 c) Upon  
 d) About

77. I assure you \_\_\_\_\_ your safety  
 a) Off                                b) Of                                c) From                                d) With
78. He competed \_\_\_\_\_ me for the prize.  
 a) Off                                b) With                                c) To                                d) Of
79. He is \_\_\_\_\_ difficulties  
 a) In                                b) On                                c) From                                d) With
80. He is true \_\_\_\_\_ his words  
 a) With                                b) On                                c) To                                d) For
81. The fan is \_\_\_\_\_ my head  
 a) Above                                b) On                                c) To                                d) With
82. You can see the house \_\_\_\_\_ the trees  
 a) To                                b) On                                c) With                                d) Among
83. Which of these is not a characteristic of a good essay?  
 a) Brevity                                b) Dignified style                                c) Fakeness                                d) Personal touch
84. Which of these should be avoided in a good essay?  
 a) Slang                                b) Dignified words                                c) Brevity                                d) Unity
85. Which of these is not a type of essay?  
 a) Narrative essay                                b) Descriptive essay                                c) Argumentative essay                                d) Personal essay
86. Which of these essays tells a story?  
 a) Narrative essays                                b) Descriptive essays  
 c) Reflective essays                                d) Argumentative essays
87. In which of these essays, the writer arrives at a conclusion by logical reasoning?  
 a) Narrative essays                                b) Descriptive essays  
 c) Reflective essays                                d) Argumentative essays
88. \_\_\_\_\_ essays are a collection of one's thoughts  
 a) Narrative                                b) Expository                                c) Argumentative                                d) Reflective
89. Which of these explains a subject?  
 a) Narrative essays                                b) Expository essays  
 c) Argumentative essays                                d) Reflective essays
90. Which kind of essay uses the five senses (touch, smell, taste, sound, sight) to enhance the imagery of the setting?  
 a) Narrative essays                                b) Descriptive essays  
 c) Expository essays                                d) Argumentative essays
91. Indirect speech is also called as :  
 a) Reported speech                                b) Quoted speech                                c) Simple speech                                d) Principal speech



92. A \_\_\_\_\_ report provides information on scientific tests carried out by engineers or scientists  
 a) progress                      b) periodic                      c) laboratory                      d) trouble
93. Convert the following direct speech to indirect :  
 She said, "My mother is cooking food".  
 a) She said that her mother was cooking food.  
 b) She said that my mother was cooking food  
 c) She said that her mother is cooking food.  
 d) She said that my mother is cooking food.
94. Change the speech for the following statement :  
 She said, "The man died in the afternoon".  
 a) She said the man died in the afternoon.  
 b) She said that the man had died in the afternoon.  
 c) She had said the man died in the afternoon.  
 d) She said the man was dead in the afternoon.
95. Convert the following statement in direct speech to indirect:  
 He said to me, "I don't believe you".  
 a) He said he didn't believe me.                      b) He said I don't believe you.  
 c) He said he don't believe me.                      d) He said I didn't believe you.
96. If the subject is of singular number, third person; in what number and person will the verb be?  
 a) Singular number, first person.                      b) Singular number, third person.  
 c) Plural number, first person.                      d) Plural number, third person.
97. Fill in the blank: Neither he nor I \_\_\_\_\_ present.  
 a) were                      b) was                      c) are                      d) am
98. Convert the affirmative sentence into a negative sentence:  
 Mili is prettier than Neha.  
 a) Neha is not as pretty as Mili.                      b) Mili is not as pretty as Neha.  
 c) Neha is not as prettier as Mili.                      d) Mili is not prettier than Neha.
99. Convert the following interrogative sentence to an assertive sentence:  
 Who would not love his country?  
 a) No one loves his country.                      b) Everyone loves his country.  
 c) Someone loves his country.                      d) Everyone loves the country.
100. Convert the following compound sentence into a simple sentence:  
 We must eat, or we cannot live.  
 a) We must live to eat.                      b) We must eat to live.  
 c) We can't live if we eat.                      d) We can't eat if we live.

USN

--	--	--	--	--	--	--	--	--	--

Question Paper Version : B

**Second Semester B.E./B.Tech./B.Arch/B.Planning Degree Examination,  
July/August 2022**

**Professional Writing Skills in English**

**(COMMON TO ALL BRANCHES)**

Time: 2 hrs.]

[Max. Marks: 100

**INSTRUCTIONS TO THE CANDIDATES**

1. Answer all the Hundred questions, each question carries **ONE mark**.
2. Use only **Black ball point pen** for writing / darkening the circles.
3. For each question, after selecting your answer, darken the appropriate circle corresponding to the same question number on the OMR sheet.
4. Darkening two circles for the same question makes the answer invalid.
5. **Damaging/overwriting, using whiteners** on the **OMR** sheets are strictly prohibited.

**Questions on Verb Correction:**

1. Correct the sentence if necessary. The girl is taking biscuits every day.
  - a) The girl is taking biscuits every day.
  - b) The girl takes biscuits every day.
  - c) The girls is taken biscuits every day.
  - d) None of these.
2. Correct the sentence if necessary. He takes milk every day.
  - a) He takes milk every day.
  - b) He is taking milk every day.
  - c) He is taken milk every day.
  - d) None of these.
3. Correct the sentence if necessary. They are coming here regularly.
  - a) They are coming here regularly.
  - b) They are come here regularly.
  - c) They come here regularly.
  - d) None of these
4. I am studying every morning from 5-8 A.M.
  - a) I am studying every morning from 5-8 A.M.
  - b) I have been studying every morning from 5-8 A.M.
  - c) I study every morning from 5-8 A.M.
  - d) None of these.
5. Every evening, he is going for a walk.
  - a) Every evening, he is going for a walk.
  - b) Every evening, he goes for a walk.
  - c) Every evening, he has been going for a walk.
  - d) None of these.
6. A writer must not convey information with \_\_\_\_\_.
  - a) precision
  - b) clarity
  - c) randomness
  - d) truth

7. Which of these are to be avoided in any style of writing?  
 a) Truth                      b) Clarity                      c) Compassion                      d) Dishonesty
8. Which of these reports are used in business?  
 a) Formal technical reports                      b) Informal reports  
 c) Personal reports                      d) Musical reports
9. Which of the following is NOT a method of writing a non-formal letter?  
 a) Filling in a blank form                      b) Form of a letter  
 c) Form of a memorandum                      d) Formal of a notice
10. A non-formal report written in the form of letter is similar to a \_\_\_\_\_.  
 a) friendly letter                      b) business letter                      c) complaint letter                      d) notice
11. Which of these does not come under reports?  
 a) News items                      b) Memorandums                      c) Notice                      d) Report cards
12. Which of these is not a parameter of a formal report?  
 a) Presentation                      b) Complaint                      c) Information                      d) Request
13. Meaning of "Fly by night"  
 a) Night journey                      b) A bird busy in night  
 c) Cat's eye                      d) Swindler
14. Synonym of Exhort  
 a) Weak Plea                      b) To urge strongly                      c) Beg                      d) Borrow
15. Antonym of Blunt  
 a) Easy                      b) Lazy                      c) Sharp                      d) Speedy
16. Antonym of Brave  
 a) Achieve                      b) Gain                      c) Give                      d) Cowardly
17. Synonym of Abjure  
 a) To give                      b) To take back                      c) Happy                      d) Sorry
18. Synonym of Abrogate  
 a) Create                      b) Run                      c) Fascinate                      d) Abolish
19. Unfortunately, he \_\_\_\_\_ a lot of money to the bank.  
 a) Borrowed                      b) Owed                      c) Deposited                      d) Lent
20. I \_\_\_\_\_ the apartment all day yesterday.  
 a) Clear                      b) Washed out                      c) Cleaned up                      d) None of these
21. The train \_\_\_\_\_ as fast as the bus.  
 a) went                      b) running                      c) moves                      d) going
22. He was seen \_\_\_\_\_ to the school.  
 a) went                      b) going                      c) gone                      d) go
23. She \_\_\_\_\_ in the sun for 1 hour  
 a) sitting                      b) has been sitting                      c) has been sit                      d) has sit

24. \_\_\_\_\_ it help you in your studies?  
 a) will                              b) was                              c) is                              d) are
25. I \_\_\_\_\_ never seen such a picture before  
 a) did                              b) was                              c) have                              d) has
26. Words of same sound is?  
 a) Soundnynms                      b) Antonyms                      c) Homonyms                      d) None of these
27. Sounding the same but spelt differently?  
 a) Symphonious                      b) Homophonous                      c) Synonyms                      d) Saminymous
28. Choose the correct answer?  
 a) My friend has got a new job                              b) My friend has got a new work  
 c) My friend is got a new job                              d) My friend did got a new job
29. Choose the correct sentence.  
 a) Do you like a glass of water?                              b) Would you like a glass of water?  
 c) Would you like the glass of water?                              d) Do you like the glass of water?
30. Antonym of Ad-lib?  
 a) Improvise                      b) Extemporized                      c) Deliberate                      d) Spontaneous
31. We \_\_\_\_\_ at the party.  
 a) Enjoyed ourself                      b) Enjoyed ourselves                      c) Played with                      d) None of these
32. Choose a correct sentence below :  
 a) There are seven girls in the class.                              b) There is seven girls in the class.  
 c) There are seven girl in the class.                              d) There is seven girl in the class.
33. I \_\_\_\_\_ a letter to the Principal yesterday  
 a) write                              b) forward                              c) mailed                              d) have signed
34. Choose the correct statement :  
 a) Although he was hurt, but he continued to walk.  
 b) Although he was hurt, he continued to walk.  
 c) He was hurt, he continued to walk.  
 d) Although he continued to walk, he was hurt.
35. Choose the correct statement :  
 a) There were between 8 to 10 policemen present.  
 b) There were between 8 and 10 policemen present.  
 c) There were among 8 to 10 policemen present.  
 d) There were atleast 8 and 10 policemen present.
36. Meaning of See Eye to Eye  
 a) To agree fully                      b) Not agreeing fully                      c) In a battle field                      d) Angry
37. He \_\_\_\_\_ a very good grade in the examination  
 a) Earned                              b) Given                              c) Received                              d) None of these

38. We \_\_\_\_\_ at the party late  
 a) arrived                      b) went                      c) played                      d) saw
39. The patient \_\_\_\_\_ in his sleep  
 a) Woke up                      b) Died                      c) Cried off                      d) None of these
40. I was delighted \_\_\_\_\_ her answer.  
 a) On                      b) At                      c) For                      d) In
41. I have no doubt \_\_\_\_\_ it.  
 a) At                      b) On                      c) Upon                      d) About
42. I assure you \_\_\_\_\_ your safety  
 a) Off                      b) Of                      c) From                      d) With
43. He competed \_\_\_\_\_ me for the prize.  
 a) Off                      b) With                      c) To                      d) Of
44. He is \_\_\_\_\_ difficulties  
 a) In                      b) On                      c) From                      d) With
45. He is true \_\_\_\_\_ his words  
 a) With                      b) On                      c) To                      d) For
46. The fan is \_\_\_\_\_ my head  
 a) Above                      b) On                      c) To                      d) With
47. You can see the house \_\_\_\_\_ the trees  
 a) To                      b) On                      c) With                      d) Among
48. Which of these is not a characteristic of a good essay?  
 a) Brevity                      b) Dignified style                      c) Fakeness                      d) Personal touch
49. Which of these should be avoided in a good essay?  
 a) Slang                      b) Dignified words                      c) Brevity                      d) Unity
50. Which of these is not a type of essay?  
 a) Narrative essay                      b) Descriptive essay                      c) Argumentative essay                      d) Personal essay
51. Which of these essays tells a story?  
 a) Narrative essays                      b) Descriptive essays  
 c) Reflective essays                      d) Argumentative essays
52. In which of these essays, the writer arrives at a conclusion by logical reasoning?  
 a) Narrative essays                      b) Descriptive essays  
 c) Reflective essays                      d) Argumentative essays
53. \_\_\_\_\_ essays are a collection of one's thoughts  
 a) Narrative                      b) Expository                      c) Argumentative                      d) Reflective



65. Convert the following compound sentence into a simple sentence:  
We must eat, or we cannot live.
- |                             |                             |
|-----------------------------|-----------------------------|
| a) We must live to eat.     | b) We must eat to live.     |
| c) We can't live if we eat. | d) We can't eat if we live. |

### General English Questions on Adjectives:

66. Correct the sentence if necessary. She is senior than me.
- |                           |                         |
|---------------------------|-------------------------|
| a) She is senior than me. | b) She is senior to me. |
| c) She is senior then me. | d) None of these.       |
67. Correct the sentence if necessary. He is junior than me.
- |                          |                          |
|--------------------------|--------------------------|
| a) He is junior than me. | b) He is junior then me. |
| c) He is junior to me.   | d) None of these.        |
68. Correct the sentence if necessary. He is senior to her.
- |                           |                           |
|---------------------------|---------------------------|
| a) He is senior than her. | b) He is senior then her. |
| c) He is senior to her.   | d) None of these.         |
69. This is preferable than that.
- |                                  |                                  |
|----------------------------------|----------------------------------|
| a) This is preferable than that. | b) This is preferable then that. |
| c) This is preferable to that.   | d) None of these.                |
70. My sister is elder than me.
- |                                |                              |
|--------------------------------|------------------------------|
| a) My sister is elder than me. | b) My sister is elder to me. |
| c) My sister is elder then me. | d) None of these.            |

### General English Questions on Pronoun Correction:

71. Correct the sentence if necessary. One should respect his elders.
- |                                     |                                   |
|-------------------------------------|-----------------------------------|
| a) One should respect his elders.   | b) One should respect her elders. |
| c) One should respect one's elders. | d) None of these.                 |
72. Correct the sentence if necessary. One should respect his own country.
- |  |  |
|--|--|
| a) One should respect his own country.   | b) One should respect her own country. |
| c) One should respect their own country. | d) One should respect one's country.   |
73. Correct the sentence if necessary. One must love his parents.
- |                                 |                                 |
|---------------------------------|---------------------------------|
| a) One must love her parents.   | b) One must love his parents.   |
| c) One must love their parents. | d) One must love one's parents. |
74. Correct the sentence if necessary. I and Jimmy went home.
- |                           |                           |
|---------------------------|---------------------------|
| a) I and Jimmy went home. | b) Jimmy and I went home. |
| c) a and b                | d) None of these.         |
75. Correct the sentence if necessary. I and she are friends.
- |                            |                           |
|----------------------------|---------------------------|
| a) I and she are friends.  | b) She and I are friends. |
| c) She and me are friends. | d) None of these.         |

76. Correct the sentence if necessary. I and Dhoni went to college.  
 a) I and Dhoni went to college.                      b) Dhoni and I went to college.  
 c) Dhoni and me went to college.                      d) None of these.
77. Correct the sentence if necessary. Both he and you must attend the meeting.  
 a) Both he and you must attend the meeting.                      b) Both you and he must attend the meeting.  
 c) a and b                      d) None of these.
78. Correct the sentence if necessary. Peter invited me and you to dinner.  
 a) Peter invited you and me to dinner.                      b) Peter invited me and you to dinner.  
 c) a and b                      d) None of these.
79. Correct the sentence if necessary. I, you and she can do it.  
 a) I, you and she can do it.                      b) You, I and she can do it.  
 c) You, she and I can do it.                      d) She, you and I can do it.
80. Correct the sentence if necessary. None of the three questions are simple.  
 a) None of the three questions are simple.                      b) None of the three questions is simple.  
 c) a and b                      d) None of these.

**General English Grammar: Select the correct option.**

81. Her thinking leans \_\_\_\_\_ democracy.  
 a) with                      b) towards                      c) for                      d) None of these
82. He got too tired \_\_\_\_\_ over work.  
 a) because of                      b) because off                      c) on                      d) for
83. \_\_\_\_\_ his principles, he has to be very careful.  
 a) with regard of                      b) with regard on                      c) with regard to                      d) None of these
84. Building has been built \_\_\_\_\_ the new plan.  
 a) accordance to                      b) in accordance with                      c) for                      d) about
85. He crossed the broken bridge \_\_\_\_\_ warning.  
 a) in spite of                      b) in spite off                      c) on                      d) about
86. Which of these do not deal with precise information?  
 a) Engineer                      b) Scientist                      c) Technician                      d) Fiction writer
87. In an office, an employee communicates horizontally with his \_\_\_\_\_.  
 a) superiors                      b) subordinates                      c) colleagues                      d) assistant
88. An average length of sentence in a paragraph should be \_\_\_\_\_.  
 a) 15 to 20 words                      b) 25 to 30 words                      c) 2 to 5 words                      d) 5 to 10 words
89. Which of these is not a feature of a paragraph?  
 a) Length                      b) Unity                      c) Incoherence                      d) Correctness



90. Which of these is not an important feature of a paragraph?  
a) Length                      b) Breadth                      c) Unity                      d) Coherence
91. Resume is called curriculum vitae in \_\_\_\_\_  
a) India                      b) France                      c) North America                      d) South America
92. Which of these letters are in response to an advertisement?  
a) Solicited letters                      b) Unsolicited letters  
c) Letters of enquiry                      d) Letters of complaint
93. Which of these letters of application must include a statement of the writer's age?  
a) For complain                      b) For employment                      c) For enquiry                      d) For adjustment
94. Technical writing demands \_\_\_\_\_ use of language.  
a) figurative                      b) poetic                      c) factual                      d) dramatic
95. Which of these must be avoided in technical writing?  
a) Facts                      b) Grammar  
c) Punctuation                      d) Personal feelings
96. Which of these words is used in technical writing?  
a) Apex                      b) Top                      c) Slanting                      d) Bottom
97. Which of these is a technical word for slanting?  
a) Lateral                      b) Sloping                      c) Tilting                      d) Bent
98. Which of these should be avoided for an effective speech?  
a) Planning of speech                      b) Preparation of speech  
c) Long sentences                      d) Organization
99. Which of these should be avoided during the delivery of a speech?  
a) Confidence                      b) Clarity                      c) Pauses                      d) Rudeness
100. Which of these is not a type of public speech?  
a) Short speech                      b) Informal speech  
c) Written speech                      d) Professional speech

USN

--	--	--	--	--	--	--	--	--	--

Question Paper Version : C

**Second Semester B.E./B.Tech./B.Arch/B.Planning Degree Examination,  
July/August 2022**

**Professional Writing Skills in English**

**(COMMON TO ALL BRANCHES)**

Time: 2 hrs.]

[Max. Marks: 100

**INSTRUCTIONS TO THE CANDIDATES**

1. Answer all the Hundred questions, each question carries **ONE** mark.
2. Use only **Black ball point pen** for writing / darkening the circles.
3. For each question, after selecting your answer, darken the appropriate circle corresponding to the same question number on the OMR sheet.
4. Darkening two circles for the same question makes the answer invalid.
5. **Damaging/overwriting, using whiteners** on the **OMR** sheets are strictly prohibited.

**General English Questions on Pronoun Correction:**

1. Correct the sentence if necessary. One should respect his elders.
  - a) One should respect his elders.
  - b) One should respect her elders.
  - c) One should respect one's elders.
  - d) None of these.
2. Correct the sentence if necessary. One should respect his own country.
  - a) One should respect his own country.
  - b) One should respect her own country.
  - c) One should respect their own country.
  - d) One should respect one's country.
3. Correct the sentence if necessary. One must love his parents.
  - a) One must love her parents.
  - b) One must love his parents.
  - c) One must love their parents.
  - d) One must love one's parents.
4. Correct the sentence if necessary. I and Jimmy went home.
  - a) I and Jimmy went home.
  - b) Jimmy and I went home.
  - c) a and b
  - d) None of these.
5. Correct the sentence if necessary. I and she are friends.
  - a) I and she are friends.
  - b) She and I are friends.
  - c) She and me are friends.
  - d) None of these.
6. Correct the sentence if necessary. I and Dhoni went to college.
  - a) I and Dhoni went to college.
  - b) Dhoni and I went to college.
  - c) Dhoni and me went to college.
  - d) None of these.

7. Correct the sentence if necessary. Both he and you must attend the meeting.  
 a) Both he and you must attend the meeting.      b) Both you and he must attend the meeting.  
 c) a and b      d) None of these.
8. Correct the sentence if necessary. Peter invited me and you to dinner.  
 a) Peter invited you and me to dinner.      b) Peter invited me and you to dinner.  
 c) a and b      d) None of these.
9. Correct the sentence if necessary. I, you and she can do it.  
 a) I, you and she can do it.      b) You, I and she can do it.  
 c) You, she and I can do it.      d) She, you and I can do it.
10. Correct the sentence if necessary. None of the three questions are simple.  
 a) None of the three questions are simple.      b) None of the three questions is simple.  
 c) a and b      d) None of these.

### Questions on Verb Correction:

11. Correct the sentence if necessary. The girl is taking biscuits every day.  
 a) The girl is taking biscuits every day.      b) The girl takes biscuits every day.  
 c) The girls is taken biscuits every day.      d) None of these.
12. Correct the sentence if necessary. He takes milk every day.  
 a) He takes milk every day.      b) He is taking milk every day.  
 c) He is taken milk every day.      d) None of these.
13. Correct the sentence if necessary. They are coming here regularly.  
 a) They are coming here regularly.      b) They are come here regularly.  
 c) They come here regularly.      d) None of these.
14. I am studying every morning from 5-8 A.M.  
 a) I am studying every morning from 5-8 A.M.  
 b) I have been studying every morning from 5-8 A.M.  
 c) I study every morning from 5-8 A.M.  
 d) None of these.
15. Every evening, he is going for a walk.  
 a) Every evening, he is going for a walk.  
 b) Every evening, he goes for a walk.  
 c) Every evening, he has been going for a walk.  
 d) None of these.
16. A writer must not convey information with \_\_\_\_\_.  
 a) precision      b) clarity      c) randomness      d) truth
17. Which of these are to be avoided in any style of writing?  
 a) Truth      b) Clarity      c) Compassion      d) Dishonesty



33. She \_\_\_\_\_ in the sun for 1 hour  
 a) sitting                      b) has been sitting                      c) has been sit                      d) has sit
34. \_\_\_\_\_ it help you in your studies?  
 a) will                      b) was                      c) is                      d) are
35. I \_\_\_\_\_ never seen such a picture before  
 a) did                      b) was                      c) have                      d) has
36. Words of same sound is?  
 a) Soundnynms                      b) Antonyms                      c) Homonyms                      d) None of these
37. Sounding the same but spelt differently?  
 a) Symphonious                      b) Homophonous                      c) Synonyms                      d) Saminyous
38. Choose the correct answer?  
 a) My friend has got a new job                      b) My friend has got a new work  
 c) My friend is got a new job                      d) My friend did got a new job
39. Choose the correct sentence.  
 a) Do you like a glass of water?                      b) Would you like a glass of water?  
 c) Would you like the glass of water?                      d) Do you like the glass of water?
40. Antonym of Ad-lib?  
 a) Improvise                      b) Extemporized                      c) Deliberate                      d) Spontaneous
41. We \_\_\_\_\_ at the party.  
 a) Enjoyed ourself                      b) Enjoyed ourselves                      c) Played with                      d) None of these
42. Choose a correct sentence below :  
 a) There are seven girls in the class.                      b) There is seven girls in the class.  
 c) There are seven girl in the class.                      d) There is seven girl in the class.
43. I \_\_\_\_\_ a letter to the Principal yesterday  
 a) write                      b) forward                      c) mailed                      d) have signed
44. Choose the correct statement :  
 a) Although he was hurt, but he continued to walk.  
 b) Although he was hurt, he continued to walk.  
 c) He was hurt, he continued to walk.  
 d) Although he continued to walk, he was hurt.
45. Choose the correct statement :  
 a) There were between 8 to 10 policemen present.  
 b) There were between 8 and 10 policemen present.  
 c) There were among 8 to 10 policemen present.  
 d) There were atleast 8 and 10 policemen present.
46. Meaning of See Eye to Eye  
 a) To agree fully                      b) Not agreeing fully                      c) In a battle field                      d) Angry

47. He \_\_\_\_\_ a very good grade in the examination  
 a) Earned                      b) Given                      c) Received                      d) None of these
48. We \_\_\_\_\_ at the party late  
 a) arrived                      b) went                      c) played                      d) saw
49. The patient \_\_\_\_\_ in his sleep  
 a) Woke up                      b) Died                      c) Cried off                      d) None of these
50. I was delighted \_\_\_\_\_ her answer.  
 a) On                      b) At                      c) For                      d) In
51. I have no doubt \_\_\_\_\_ it.  
 a) At                      b) On                      c) Upon                      d) About
52. I assure you \_\_\_\_\_ your safety  
 a) Off                      b) Of                      c) From                      d) With
53. He competed \_\_\_\_\_ me for the prize.  
 a) Off                      b) With                      c) To                      d) Of
54. He is \_\_\_\_\_ difficulties  
 a) In                      b) On                      c) From                      d) With
55. He is true \_\_\_\_\_ his words  
 a) With                      b) On                      c) To                      d) For
56. The fan is \_\_\_\_\_ my head  
 a) Above                      b) On                      c) To                      d) With
57. You can see the house \_\_\_\_\_ the trees  
 a) To                      b) On                      c) With                      d) Among
58. Which of these is not a characteristic of a good essay?  
 a) Brevity                      b) Dignified style                      c) Fakeness                      d) Personal touch
59. Which of these should be avoided in a good essay?  
 a) Slang                      b) Dignified words                      c) Brevity                      d) Unity
60. Which of these is not a type of essay?  
 a) Narrative essay                      b) Descriptive essay                      c) Argumentative essay                      d) Personal essay
61. Which of these essays tells a story?  
 a) Narrative essays                      b) Descriptive essays  
 c) Reflective essays                      d) Argumentative essays
62. In which of these essays, the writer arrives at a conclusion by logical reasoning?  
 a) Narrative essays                      b) Descriptive essays  
 c) Reflective essays                      d) Argumentative essays

63. \_\_\_\_\_ essays are a collection of one's thoughts  
 a) Narrative                      b) Expository                      c) Argumentative                      d) Reflective
64. Which of these explains a subject?  
 a) Narrative essays                      b) Expository essays  
 c) Argumentative essays                      d) Reflective essays
65. Which kind of essay uses the five senses (touch, smell, taste, sound, sight) to enhance the imagery of the setting?  
 a) Narrative essays                      b) Descriptive essays  
 c) Expository essays                      d) Argumentative essays
66. Indirect speech is also called as :  
 a) Reported speech    b) Quoted speech                      c) Simple speech                      d) Principal speech
67. A \_\_\_\_\_ report provides information on scientific tests carried out by engineers or scientists  
 a) progress                      b) periodic                      c) laboratory                      d) trouble
68. Convert the following direct speech to indirect :  
 She said, "My mother is cooking food".  
 a) She said that her mother was cooking food.  
 b) She said that my mother was cooking food  
 c) She said that her mother is cooking food.  
 d) She said that my mother is cooking food.
69. Change the speech for the following statement :  
 She said, "The man died in the afternoon".  
 a) She said the man died in the afternoon.  
 b) She said that the man had died in the afternoon.  
 c) She had said the man died in the afternoon.  
 d) She said the man was dead in the afternoon.
70. Convert the following statement in direct speech to indirect:  
 He said to me, "I don't believe you".  
 a) He said he didn't believe me.                      b) He said I don't believe you.  
 c) He said he don't believe me.                      d) He said I didn't believe you.
71. If the subject is of singular number, third person; in what number and person will the verb be?  
 a) Singular number, first person.                      b) Singular number, third person.  
 c) Plural number, first person.                      d) Plural number, third person.
72. Fill in the blank: Neither he nor I \_\_\_\_\_ present.  
 a) were                      b) was                      c) are                      d) am
73. Convert the affirmative sentence into a negative sentence:  
 Mili is prettier than Neha.  
 a) Neha is not as pretty as Mili.                      b) Mili is not as pretty as Neha.  
 c) Neha is not as prettier as Mili.                      d) Mili is not prettier than Neha.





88. Which of these letters of application must include a statement of the writer's age?  
 a) For complain      b) For employment      c) For enquiry      d) For adjustment
89. Technical writing demands \_\_\_\_\_ use of language.  
 a) figurative      b) poetic      c) factual      d) dramatic
90. Which of these must be avoided in technical writing?  
 a) Facts      b) Grammar  
 c) Punctuation      d) Personal feelings
91. Which of these words is used in technical writing?  
 a) Apex      b) Top      c) Slanting      d) Bottom
92. Which of these is a technical word for slanting?  
 a) Lateral      b) Sloping      c) Tilting      d) Bent
93. Which of these should be avoided for an effective speech?  
 a) Planning of speech      b) Preparation of speech  
 c) Long sentences      d) Organization
94. Which of these should be avoided during the delivery of a speech?  
 a) Confidence      b) Clarity      c) Pauses      d) Rudeness
95. Which of these is not a type of public speech?  
 a) Short speech      b) Informal speech  
 c) Written speech      d) Professional speech

#### General English Questions on Adjectives:

96. Correct the sentence if necessary. She is senior than me.  
 a) She is senior than me.      b) She is senior to me.  
 c) She is senior then me.      d) None of these.
97. Correct the sentence if necessary. He is junior than me.  
 a) He is junior than me.      b) He is junior then me.  
 c) He is junior to me.      d) None of these.
98. Correct the sentence if necessary. He is senior to her.  
 a) He is senior than her.      b) He is senior then her.  
 c) He is senior to her.      d) None of these.
99. This is preferable than that.  
 a) This is preferable than that.      b) This is preferable then that.  
 c) This is preferable to that.      d) None of these.
100. My sister is elder than me.  
 a) My sister is elder than me.      b) My sister is elder to me.  
 c) My sister is elder then me.      d) None of these.

USN

--	--	--	--	--	--	--	--	--	--

Question Paper Version : D

**Second Semester B.E./B.Tech./B.Arch/B.Planning Degree Examination,  
July/August 2022**

**Professional Writing Skills in English**

**(COMMON TO ALL BRANCHES)**

Time: 2 hrs.]

[Max. Marks: 100

**INSTRUCTIONS TO THE CANDIDATES**

1. Answer all the Hundred questions, each question carries **ONE mark**.
2. Use only **Black ball point pen** for writing / darkening the circles.
3. For each question, after selecting your answer, darken the appropriate circle corresponding to the same question number on the OMR sheet.
4. Darkening two circles for the same question makes the answer invalid.
5. **Damaging/overwriting, using whiteners** on the **OMR** sheets are strictly prohibited.

**General English Questions on Adjectives:**

1. Correct the sentence if necessary. She is senior than me.
 

a) She is senior than me.	b) She is senior to me.
c) She is senior then me.	d) None of these.
2. Correct the sentence if necessary. He is junior than me.
 

a) He is junior than me.	b) He is junior then me.
c) He is junior to me.	d) None of these.
3. Correct the sentence if necessary. He is senior to her.
 

a) He is senior than her.	b) He is senior then her.
c) He is senior to her.	d) None of these.
4. This is preferable than that.
 

a) This is preferable than that.	b) This is preferable then that.
c) This is preferable to that.	d) None of these.
5. My sister is elder than me.
 

a) My sister is elder than me.	b) My sister is elder to me.
c) My sister is elder then me.	d) None of these.

**General English Grammar: Select the correct option.**

6. Her thinking leans \_\_\_\_\_ democracy.  
a) with                      b) towards                      c) for                      d) None of these
7. He got too tired \_\_\_\_\_ over work.  
a) because of                      b) because off                      c) on                      d) for
8. \_\_\_\_\_ his principles, he has to be very careful.  
a) with regard of                      b) with regard on                      c) with regard to                      d) None of these
9. Building has been built \_\_\_\_\_ the new plan.  
a) accordance to                      b) in accordance with                      c) for                      d) about
10. He crossed the broken bridge \_\_\_\_\_ warning.  
a) in spite of                      b) in spite off                      c) on                      d) about
11. Which of these do not deal with precise information?  
a) Engineer                      b) Scientist                      c) Technician                      d) Fiction writer
12. In an office, an employee communicates horizontally with his \_\_\_\_\_.  
a) superiors                      b) subordinates                      c) colleagues                      d) assistant
13. An average length of sentence in a paragraph should be \_\_\_\_\_.  
a) 15 to 20 words                      b) 25 to 30 words                      c) 2 to 5 words                      d) 5 to 10 words
14. Which of these is not a feature of a paragraph?  
a) Length                      b) Unity                      c) Incoherence                      d) Correctness
15. Which of these is not an important feature of a paragraph?  
a) Length                      b) Breadth                      c) Unity                      d) Coherence
16. Resume is called curriculum vitae in \_\_\_\_\_.  
a) India                      b) France                      c) North America                      d) South America
17. Which of these letters are in response to an advertisement?  
a) Solicited letters                      b) Unsolicited letters  
c) Letters of enquiry                      d) Letters of complaint
18. Which of these letters of application must include a statement of the writer's age?  
a) For complain                      b) For employment                      c) For enquiry                      d) For adjustment
19. Technical writing demands \_\_\_\_\_ use of language.  
a) figurative                      b) poetic                      c) factual                      d) dramatic
20. Which of these must be avoided in technical writing?  
a) Facts                      b) Grammar  
c) Punctuation                      d) Personal feelings

21. Which of these words is used in technical writing?  
 a) Apex                                      b) Top                                      c) Slanting                                      d) Bottom
22. Which of these is a technical word for slanting?  
 a) Lateral                                      b) Sloping                                      c) Tilting                                      d) Bent
23. Which of these should be avoided for an effective speech?  
 a) Planning of speech                                      b) Preparation of speech  
 c) Long sentences                                      d) Organization
24. Which of these should be avoided during the delivery of a speech?  
 a) Confidence                                      b) Clarity                                      c) Pauses                                      d) Rudeness
25. Which of these is not a type of public speech?  
 a) Short speech                                      b) Informal speech  
 c) Written speech                                      d) Professional speech

#### Questions on Verb Correction:

26. Correct the sentence if necessary. The girl is taking biscuits every day.  
 a) The girl is taking biscuits every day.                                      b) The girl takes biscuits every day.  
 c) The girls is taken biscuits every day.                                      d) None of these.
27. Correct the sentence if necessary. He takes milk every day.  
 a) He takes milk every day.                                      b) He is taking milk every day.  
 c) He is taken milk every day.                                      d) None of these.
28. Correct the sentence if necessary. They are coming here regularly.  
 a) They are coming here regularly.                                      b) They are come here regularly.  
 c) They come here regularly.                                      d) None of these
29. I am studying every morning from 5-8 A.M.  
 a) I am studying every morning from 5-8 A.M.  
 b) I have been studying every morning from 5-8 A.M.  
 c) I study every morning from 5-8 A.M.  
 d) None of these.
30. Every evening, he is going for a walk.  
 a) Every evening, he is going for a walk.  
 b) Every evening, he goes for a walk.  
 c) Every evening, he has been going for a walk.  
 d) None of these.
31. A writer must not convey information with \_\_\_\_\_.  
 a) precision                                      b) clarity                                      c) randomness                                      d) truth
32. Which of these are to be avoided in any style of writing?  
 a) Truth                                      b) Clarity                                      c) Compassion                                      d) Dishonesty



49. \_\_\_\_\_ it help you in your studies?  
 a) will                                      b) was                                      c) is                                      d) are
50. I \_\_\_\_\_ never seen such a picture before  
 a) did                                      b) was                                      c) have                                      d) has
51. Words of same sound is?  
 a) Soundnynms                      b) Antonyms                      c) Homonyms                      d) None of these
52. Sounding the same but spelt differently?  
 a) Symphonious                      b) Homophonous                      c) Synonyms                      d) Saminymous
53. Choose the correct answer?  
 a) My friend has got a new job                      b) My friend has got a new work  
 c) My friend is got a new job                      d) My friend did got a new job
54. Choose the correct sentence.  
 a) Do you like a glass of water?                      b) Would you like a glass of water?  
 c) Would you like the glass of water?                      d) Do you like the glass of water?
55. Antonym of Ad-lib?  
 a) Improvise                      b) Extemporized                      c) Deliberate                      d) Spontaneous
56. We \_\_\_\_\_ at the party.  
 a) Enjoyed ourself                      b) Enjoyed ourselves                      c) Played with                      d) None of these
57. Choose a correct sentence below :  
 a) There are seven girls in the class.                      b) There is seven girls in the class.  
 c) There are seven girl in the class.                      d) There is seven girl in the class.
58. I \_\_\_\_\_ a letter to the Principal yesterday  
 a) write                      b) forward                      c) mailed                      d) have signed
59. Choose the correct statement :  
 a) Although he was hurt, but he continued to walk.  
 b) Although he was hurt, he continued to walk.  
 c) He was hurt, he continued to walk.  
 d) Although he continued to walk, he was hurt.
60. Choose the correct statement :  
 a) There were between 8 to 10 policemen present.  
 b) There were between 8 and 10 policemen present.  
 c) There were among 8 to 10 policemen present.  
 d) There were atleast 8 and 10 policemen present.
61. Meaning of See Eye to Eye  
 a) To agree fully                      b) Not agreeing fully                      c) In a battle field                      d) Angry
62. He \_\_\_\_\_ a very good grade in the examination  
 a) Earned                      b) Given                      c) Received                      d) None of these

63. We \_\_\_\_\_ at the party late  
 a) arrived                      b) went                      c) played                      d) saw
64. The patient \_\_\_\_\_ in his sleep  
 a) Woke up                      b) Died                      c) Cried off                      d) None of these
65. I was delighted \_\_\_\_\_ her answer.  
 a) On                      b) At                      c) For                      d) In
66. I have no doubt \_\_\_\_\_ it.  
 a) At                      b) On                      c) Upon                      d) About
67. I assure you \_\_\_\_\_ your safety  
 a) Off                      b) Of                      c) From                      d) With
68. He competed \_\_\_\_\_ me for the prize.  
 a) Off                      b) With                      c) To                      d) Of
69. He is \_\_\_\_\_ difficulties  
 a) In                      b) On                      c) From                      d) With
70. He is true \_\_\_\_\_ his words  
 a) With                      b) On                      c) To                      d) For
71. The fan is \_\_\_\_\_ my head  
 a) Above                      b) On                      c) To                      d) With
72. You can see the house \_\_\_\_\_ the trees  
 a) To                      b) On                      c) With                      d) Among
73. Which of these is not a characteristic of a good essay?  
 a) Brevity                      b) Dignified style                      c) Fakeness                      d) Personal touch
74. Which of these should be avoided in a good essay?  
 a) Slang                      b) Dignified words                      c) Brevity                      d) Unity
75. Which of these is not a type of essay?  
 a) Narrative essay                      b) Descriptive essay                      c) Argumentative essay                      d) Personal essay
76. Which of these essays tells a story?  
 a) Narrative essays                      b) Descriptive essays  
 c) Reflective essays                      d) Argumentative essays
77. In which of these essays, the writer arrives at a conclusion by logical reasoning?  
 a) Narrative essays                      b) Descriptive essays  
 c) Reflective essays                      d) Argumentative essays
78. \_\_\_\_\_ essays are a collection of one's thoughts  
 a) Narrative                      b) Expository                      c) Argumentative                      d) Reflective





90. Convert the following compound sentence into a simple sentence:  
We must eat, or we cannot live.
- |                             |                             |
|-----------------------------|-----------------------------|
| a) We must live to eat.     | b) We must eat to live.     |
| c) We can't live if we eat. | d) We can't eat if we live. |

**General English Questions on Pronoun Correction:**

91. Correct the sentence if necessary. One should respect his elders.
- |                                     |                                   |
|-------------------------------------|-----------------------------------|
| a) One should respect his elders.   | b) One should respect her elders. |
| c) One should respect one's elders. | d) None of these.                 |
92. Correct the sentence if necessary. One should respect his own country.
- |  |  |
|--|--|
| a) One should respect his own country.   | b) One should respect her own country. |
| c) One should respect their own country. | d) One should respect one's country.   |
93. Correct the sentence if necessary. One must love his parents.
- |                                 |                                 |
|---------------------------------|---------------------------------|
| a) One must love her parents.   | b) One must love his parents.   |
| c) One must love their parents. | d) One must love one's parents. |
94. Correct the sentence if necessary. I and Jimmy went home.
- |                           |                           |
|---------------------------|---------------------------|
| a) I and Jimmy went home. | b) Jimmy and I went home. |
| c) a and b.               | d) None of these.         |
95. Correct the sentence if necessary. I and she are friends.
- |                            |                           |
|----------------------------|---------------------------|
| a) I and she are friends.  | b) She and I are friends. |
| c) She and me are friends. | d) None of these.         |
96. Correct the sentence if necessary. I and Dhoni went to college.
- |                                  |                                 |
|----------------------------------|---------------------------------|
| a) I and Dhoni went to college.  | b) Dhoni and I went to college. |
| c) Dhoni and me went to college. | d) None of these.               |
97. Correct the sentence if necessary. Both he and you must attend the meeting.
- |   |   |
|---|---|
| a) Both he and you must attend the meeting. | b) Both you and he must attend the meeting. |
| c) a and b                                  | d) None of these.                           |
98. Correct the sentence if necessary. Peter invited me and you to dinner.
- |  |  |
|--|--|
| a) Peter invited you and me to dinner. | b) Peter invited me and you to dinner. |
| c) a and b                             | d) None of these.                      |
99. Correct the sentence if necessary. I, you and she can do it.
- |                              |                              |
|------------------------------|------------------------------|
| a) I, you and she can do it. | b) You, I and she can do it. |
| c) You, she and I can do it. | d) She, you and I can do it. |
100. Correct the sentence if necessary. None of the three questions are simple.
- |  |   |
|--|---|
| a) None of the three questions are simple. | b) None of the three questions is simple. |
| c) a and b                                 | d) None of these.                         |

USN

--	--	--	--	--	--	--	--	--	--

Question Paper Version : A

**First/Second Semester B.E./B.Tech./B.Arch./B.Planning Degree  
Examination, July/August 2022**

## **Innovation and Design Thinking**

**(COMMON TO ALL BRANCHES)**

Time: 1 hr.]

[Max. Marks: 50

### **INSTRUCTIONS TO THE CANDIDATES**

1. Answer all the fifty questions, each question carries one mark.
2. Use only **Black ball point pen** for writing / darkening the circles.
3. **For each question, after selecting your answer, darken the appropriate circle corresponding to the same question number on the OMR sheet.**
4. Darkening two circles for the same question makes the answer invalid.
5. **Damaging/overwriting, using whiteners on the OMR sheets are strictly prohibited.**

- 
1. What are the steps in Design Thinking Process in sequence?  
a) Define – Empathize – Ideate – Prototype – Test and Implement  
b) Test and Implement – Define – Empathize – Ideate – Prototype  
c) Empathize – Define – Ideate – Prototype – Test and Implement  
d) Ideate – Define – Empathize – Test and Implement – Prototype
  2. Which of the following Firm is associated most with Design Thinking?  
a) IKEA                      b) IDEO                      c) IDEA                      d) ASCI
  3. In which step of Design Thinking approach, actual requirements together with un-met needs of customer/end-user is addressed:  
a) Empathize                      b) Ideate                      c) Define                      d) Prototype
  4. Which of the following is best suited to produce more innovative design solutions :  
a) Monodisciplinary and untrained teams                      b) Monodisciplinary and trained teams  
c) Multidisciplinary and untrained teams                      d) Multidisciplinary and trained teams
  5. MVP stands for :  
a) Minimum Value Product                      b) Moderate Value Product  
c) Minimum Viable Product                      d) Maximum Viable Production
  6. POV is :  
a) Pin Of View which is 1<sup>st</sup> part of Empathizing  
b) Point Of View which is last part of Define stage  
c) Point Of View which is last part of Testing  
d) Pin Of View which is last part of Prototype.

7. During which stage would you consult experts to learn more about the areas of concern and to gain an understanding of other people's experiences?  
 a) Prototype                      b) Define                      c) Ideate                      d) Empathize
8. Design thinking is :  
 a) Thinking about design  
 b) Designing ways in which people think  
 c) Asking users to solve problems  
 d) Defining, framing and solving problems from user's perspectives.
9. To Empathize, one has to  
 a) Observe                      b) Engage                      c) Listen                      d) All of these
10. Collecting \_\_\_\_\_ is an important portion of testing a prototype in the Test Stage of design thinking.  
 a) Pictures                      b) Money                      c) Feedback                      d) E-Mails
11. The Tool which uses image and allow us to think nonverbally is  
 a) Value chain analysis                      b) Journey mapping  
 c) Visualization                      d) Assumption testing
12. Which tool is used as an ethnographic research method that focuses on tracing customer's journey?  
 a) Journey mapping                      b) Rapid prototyping                      c) Visualization                      d) Mind mapping.
13. Which tool is used in generating hypothesis about potential new business opportunities:  
 a) Rapid concept development                      b) Mind Mapping  
 c) Both a and b                      d) None of these
14. In value chain analysis client activity includes :  
 a) Order taking                      b) Scheduling  
 c) Software development                      d) All of these
15. Which tool is designed to test the value generating assumptions of a potential new growth initiative?  
 a) Visualization                      b) Mind Mapping                      c) Learning Launches                      d) None of these.
16. Select odd one out:  
 a) Brain storming                      b) Mind Mapping                      c) Empathy                      d) Rapid concept
17. Which of the following statement is correct :  
 a) Design thinking is Convergence-Divergence process  
 b) Design thinking is Lean start-up process  
 c) Design thinking is Linear process for product development  
 d) None of the above.
18. In Design thinking, where does the information used to put together a problem statement came from:  
 a) The Define stage                      b) Empathize stage                      c) Testing state                      d) Prototype stage
19. What is the way to narrow down the thoughts to reach at the final solution:  
 a) Convergent thinking                      b) Divergent thinking  
 c) None of these                      d) Both a and b

20. The goal of the prototype phase is  
 a) To understand what component of your idea didn't work  
 b) To understand what component of your idea work  
 c) Both a and b  
 d) None of these
21. Being an experimental phase, continuous iterations can take place in which phase:  
 a) Define  
 b) Empathize  
 c) Prototype  
 d) None of these
22. Which of the following is not tools of Design thinking?  
 a) Co-creation  
 b) Prototyping  
 c) Mind Mapping  
 d) On-Line Marketing
23. Journey mapping maps which phase of activity of service for a customer?  
 a) Before a service  
 b) During a service  
 c) After a service  
 d) All of these.
24. Value chain analysis examines how an organization interacts with value chain partners to \_\_\_\_\_ new offerings.  
 a) Produce  
 b) market  
 c) Distribute  
 d) All of these.
25. A prototype is simple experimental model of a proposed solution used to :  
 a) Test Ideas  
 b) Validate Ideas  
 c) Both a and b  
 d) None of these
26. A Hypothesis is \_\_\_\_\_.  
 a) statement indicating the profitability of company  
 b) statement indicating the Delivery time of a product  
 c) conjecture that is grounded in support background originating from secondary research  
 d) None of the above
27. What is you first model/design of a product called:  
 a) Draft  
 b) Rough draft  
 c) Prototype  
 d) Practice design
28. To Ideate is :  
 a) To change rapidly  
 b) creating 3D model of your design  
 c) Creating and sharing ideas using Images/Sketches to describe your idea  
 d) Selling a product/service at huge profit
29. A case study is :  
 a) Research strategy  
 b) Emperical enquiry  
 c) Descriptive and exploratory analysis  
 d) All of these
30. At what step, POV (Point Of View) is completed :  
 a) Empathy  
 b) Prototype  
 c) Define  
 d) Ideate
31. Design thinking principles do not include  
 a) feasibility  
 b) viability  
 c) desirability  
 d) credibility
32. The final step in the Design thinking process is  
 a) Test  
 b) Define  
 c) Ideate  
 d) Empathize
33. The three I's of Design thinking do not include  
 a) Interest  
 b) Implementation  
 c) Inspiration  
 d) Ideation
34. Ram is creating a new food product using Design thinking approach. His first step is addressing who he is creating the product for and conducts research on understanding this target market. This step is :  
 a) Define  
 b) Ideate  
 c) Empathize  
 d) Prototype



USN

--	--	--	--	--	--	--	--	--	--

Question Paper Version : B

**First/Second Semester B.E./B.Tech./B.Arch./B.Planning Degree  
Examination, July/August 2022**

## **Innovation and Design Thinking**

**(COMMON TO ALL BRANCHES)**

Time: 1 hr.]

[Max. Marks: 50

### **INSTRUCTIONS TO THE CANDIDATES**

1. Answer all the fifty questions, each question carries one mark.
2. Use only **Black ball point pen** for writing / darkening the circles.
3. **For each question, after selecting your answer, darken the appropriate circle corresponding to the same question number on the OMR sheet.**
4. Darkening two circles for the same question makes the answer invalid.
5. **Damaging/overwriting, using whiteners on the OMR sheets are strictly prohibited.**

1. Agile methodology involved  
 a) sprints                                      b) no iteration                                      c) profit                                      d) none of these
2. Which model provides better collaboration and communication?  
 a) Waterfall model      b) Agile model                                      c) Both a and b                                      d) None of these
3. Major difference between Agile model and Water fall model is  
 a) Agile model includes iteration                                      b) Waterfall model includes iteration  
 c) BPM model include iteration                                      d) None of these
4. “Invest in user research” – here word “user research” belongs to  
 a) Empathize                                      b) Design                                      c) Ideate                                      d) Testing
5. Parameters which are absolutely necessary in Agile model :  
 a) Transparency                                      b) Inspection                                      c) Adaptation                                      d) All of these
6. \_\_\_\_\_ approach is used for designing complex software systems.  
 a) Scenario based prototyping                                      b) BPM  
 c) Both a and b                                      d) None of these
7. \_\_\_\_\_ is type of collaboration where participants regardless of their location, work together to reach a certain GOAL:  
 a) Cloud Computing      b) Off-Line class                                      c) Distributed Collaboration      d) None of these
8. Digital space is also called as  
 a) Cloud computing      b) Design analysis                                      c) Distributed Design                                      d) None of these

9. Example for Distributed collaboration  
a) Mobile Manufacturing b) Machine manufacturing c) Both a and b d) None of these
10. Design thinking helps in the following :  
a) Innovation b) Statistics c) Data analysis d) None of these
11. Design thinking principles do not include  
a) feasibility b) viability c) desirability d) credibility
12. The final step in the Design thinking process is  
a) Test b) Define c) Ideate d) Empathize
13. The three I's of Design thinking do not include  
a) Interest b) Implementation c) Inspiration d) Ideation
14. Ram is creating a new food product using Design thinking approach. His first step is addressing who he is creating the product for and conducts research on understanding this target market. This step is :  
a) Define b) Ideate c) Empathize d) Prototype
15. Collaborative teamwork is essential in design thinking for  
a) Making profit b) Closing down the operations  
c) Better failure management d) None of these
16. The ultimate goal of design thinking is to help designing:  
a) Better service b) Better products c) Both a and b d) None of these
17. Design thinking is typically a  
a) Non-linear process b) Linear process c) Both a and b d) None of these
18. Design thinking follows  
a) Waterfall model b) Agile Methodology c) Both a and b d) None of these
19. \_\_\_\_\_ is an iterative and incremental method of managing development and design.  
a) Waterfall model b) Agile Methodology c) Cyclic model d) All of these
20. BPM stands for  
a) Building Project Management b) Basic Product Management  
c) Business Process Management d) Business Product Management
21. The Tool which uses image and allow us to think nonverbally is  
a) Value chain analysis b) Journey mapping  
c) Visualization d) Assumption testing
22. Which tool is used as an ethnographic research method that focuses on tracing customer's journey?  
a) Journey mapping b) Rapid prototyping c) Visualization d) Mind mapping.
23. Which tool is used in generating hypothesis about potential new business opportunities:  
a) Rapid concept development b) Mind Mapping  
c) Both a and b d) None of these
24. In value chain analysis client activity includes :  
a) Order taking b) Scheduling  
c) Software development d) All of these

25. Which tool is designed to test the value generating assumptions of a potential new growth initiative?  
 a) Visualization      b) Mind Mapping      c) Learning Launches      d) None of these.
26. Select odd one out:  
 a) Brain storming      b) Mind Mapping      c) Empathy      d) Rapid concept
27. Which of the following statement is correct :  
 a) Design thinking is Convergence-Divergence process  
 b) Design thinking is Lean start-up process  
 c) Design thinking is Linear process for product development  
 d) None of the above.
28. In Design thinking, where does the information used to put together a problem statement came from:  
 a) The Define stage      b) Empathize stage      c) Testing state      d) Prototype stage
29. What is the way to narrow down the thoughts to reach at the final solution:  
 a) Convergent thinking      b) Divergent thinking  
 c) None of these      d) Both a and b
30. The goal of the prototype phase is  
 a) To understand what component of your idea didn't work  
 b) To understand what component of your idea work  
 c) Both a and b      d) None of these
31. What are the steps in Design Thinking Process in sequence?  
 a) Define – Empathize – Ideate – Prototype – Test and Implement  
 b) Test and Implement – Define – Empathize – Ideate – Prototype  
 c) Empathize – Define – Ideate – Prototype – Test and Implement  
 d) Ideate – Define – Empathize – Test and Implement – Prototype
32. Which of the following Firm is associated most with Design Thinking?  
 a) IKEA      b) IDEO      c) IDEA      d) ASCI
33. In which step of Design Thinking approach, actual requirements together with un-met needs of customer/end-user is addressed:  
 a) Empathize      b) Ideate      c) Define      d) Prototype
34. Which of the following is best suited to produce more innovative design solutions :  
 a) Monodisciplinary and untrained teams      b) Monodisciplinary and trained teams  
 c) Multidisciplinary and untrained teams      d) Multidisciplinary and trained teams
35. MVP stands for :  
 a) Minimum Value Product      b) Moderate Value Product  
 c) Minimum Viable Product      d) Maximum Viable Production
36. POV is :  
 a) Pin Of View which is 1<sup>st</sup> part of Empathizing  
 b) Point Of View which is last part of Define stage  
 c) Point Of View which is last part of Testing  
 d) Pin Of View which is last part of Prototype.



37. During which stage would you consult experts to learn more about the areas of concern and to gain an understanding of other people's experiences?  
 a) Prototype                      b) Define                      c) Ideate                      d) Empathize
38. Design thinking is :  
 a) Thinking about design  
 b) Designing ways in which people think  
 c) Asking users to solve problems  
 d) Defining, framing and solving problems from user's perspectives.
39. To Empathize, one has to  
 a) Observe                      b) Engage                      c) Listen                      d) All of these
40. Collecting \_\_\_\_\_ is an important portion of testing a prototype in the Test Stage of design thinking.  
 a) Pictures                      b) Money                      c) Feedback                      d) E-Mails
41. Being an experimental phase, continuous iterations can take place in which phase:  
 a) Define                      b) Empathize                      c) Prototype                      d) None of these
42. Which of the following is not tools of Design thinking?  
 a) Co-creation                      b) Prototyping                      c) Mind Mapping                      d) On-Line Marketing
43. Journey mapping maps which phase of activity of service for a customer?  
 a) Before a service                      b) During a service                      c) After a service                      d) All of these.
44. Value chain analysis examines how an organization interacts with value chain partners to \_\_\_\_\_ new offerings.  
 a) Produce                      b) market                      c) Distribute                      d) All of these.
45. A prototype is simple experimental model of a proposed solution used to :  
 a) Test Ideas                      b) Validate Ideas                      c) Both a and b                      d) None of these
46. A Hypothesis is \_\_\_\_\_.  
 a) statement indicating the profitability of company  
 b) statement indicating the Delivery time of a product  
 c) conjecture that is grounded in support background originating from secondary research  
 d) None of the above
47. What is your first model/design of a product called:  
 a) Draft                      b) Rough draft                      c) Prototype                      d) Practice design
48. To Ideate is :  
 a) To change rapidly                      b) creating 3D model of your design  
 c) Creating and sharing ideas using Images/Sketches to describe your idea  
 d) Selling a product/service at huge profit
49. A case study is :  
 a) Research strategy                      b) Empirical enquiry  
 c) Descriptive and exploratory analysis                      d) All of these
50. At what step, POV (Point Of View) is completed :  
 a) Empathy                      b) Prototype                      c) Define                      d) Ideate

\* \* \* \* \*

USN

--	--	--	--	--	--	--	--	--	--

Question Paper Version : C

**First/Second Semester B.E./B.Tech./B.Arch./B.Planning Degree  
Examination, July/August 2022**

## Innovation and Design Thinking

(COMMON TO ALL BRANCHES)

Time: 1 hr.]

[Max. Marks: 50

### INSTRUCTIONS TO THE CANDIDATES

1. Answer all the fifty questions, each question carries one mark.
2. Use only **Black ball point pen** for writing / darkening the circles.
3. **For each question, after selecting your answer, darken the appropriate circle corresponding to the same question number on the OMR sheet.**
4. Darkening two circles for the same question makes the answer invalid.
5. **Damaging/overwriting, using whiteners** on the **OMR** sheets are strictly prohibited.

1. Being an experimental phase, continuous iterations can take place in which phase:  
a) Define                      b) Empathize                      c) Prototype                      d) None of these
2. Which of the following is not tools of Design thinking?  
a) Co-creation                      b) Prototyping                      c) Mind Mapping                      d) On-Line Marketing
3. Journey mapping maps which phase of activity of service for a customer?  
a) Before a service                      b) During a service                      c) After a service                      d) All of these.
4. Value chain analysis examines how an organization interacts with value chain partners to \_\_\_\_\_ new offerings.  
a) Produce                      b) market                      c) Distribute                      d) All of these.
5. A prototype is simple experimental model of a proposed solution used to :  
a) Test Ideas                      b) Validate Ideas                      c) Both a and b                      d) None of these
6. A Hypothesis is \_\_\_\_\_.  
a) statement indicating the profitability of company  
b) statement indicating the Delivery time of a product  
c) conjecture that is grounded in support background originating from secondary research  
d) None of the above
7. What is your first model/design of a product called:  
a) Draft                      b) Rough draft                      c) Prototype                      d) Practice design
8. To Ideate is :  
a) To change rapidly                      b) creating 3D model of your design  
c) Creating and sharing ideas using Images/Sketches to describe your idea  
d) Selling a product/service at huge profit







USN

--	--	--	--	--	--	--	--	--	--

Question Paper Version : D

**First/Second Semester B.E./B.Tech./B.Arch./B.Planning Degree  
Examination, July/August 2022**

## Innovation and Design Thinking

(COMMON TO ALL BRANCHES)

Time: 1 hr.]

[Max. Marks: 50

### INSTRUCTIONS TO THE CANDIDATES

1. Answer all the fifty questions, each question carries one mark.
2. Use only **Black ball point pen** for writing / darkening the circles.
3. **For each question, after selecting your answer, darken the appropriate circle corresponding to the same question number on the OMR sheet.**
4. Darkening two circles for the same question makes the answer invalid.
5. **Damaging/overwriting, using whiteners on the OMR sheets are strictly prohibited.**

1. Design thinking principles do not include  
 a) feasibility                      b) viability                      c) desirability                      d) credibility
2. The final step in the Design thinking process is  
 a) Test                      b) Define                      c) Ideate                      d) Empathize
3. The three I's of Design thinking do not include  
 a) Interest                      b) Implementation                      c) Inspiration                      d) Ideation
4. Ram is creating a new food product using Design thinking approach. His first step is addressing who he is creating the product for and conducts research on understanding this target market. This step is :  
 a) Define                      b) Ideate                      c) Empathize                      d) Prototype
5. Collaborative teamwork is essential in design thinking for  
 a) Making profit                      b) Closing down the operations  
 c) Better failure management                      d) None of these
6. The ultimate goal of design thinking is to help designing:  
 a) Better service                      b) Better products                      c) Both a and b                      d) None of these
7. Design thinking is typically a  
 a) Non-linear process                      b) Linear process                      c) Both a and b                      d) None of these
8. Design thinking follows  
 a) Waterfall model                      b) Agile Methodology                      c) Both a and b                      d) None of these

9. \_\_\_\_\_ is an iterative and incremental method of managing development and design.  
 a) Waterfall model    b) Agile Methodology    c) Cyclic model    d) All of these
10. BPM stands for  
 a) Building Project Management    b) Basic Product Management  
 c) Business Process Management    d) Business Product Management
11. What are the steps in Design Thinking Process in sequence?  
 a) Define – Empathize – Ideate – Prototype – Test and Implement  
 b) Test and Implement – Define – Empathize – Ideate – Prototype  
 c) Empathize – Define – Ideate – Prototype – Test and Implement  
 d) Ideate – Define – Empathize – Test and Implement – Prototype
12. Which of the following Firm is associated most with Design Thinking?  
 a) IKEA    b) IDEO    c) IDEA    d) ASCI
13. In which step of Design Thinking approach, actual requirements together with un-met needs of customer/end-user is addressed:  
 a) Empathize    b) Ideate    c) Define    d) Prototype
14. Which of the following is best suited to produce more innovative design solutions :  
 a) Monodisciplinary and untrained teams    b) Monodisciplinary and trained teams  
 c) Multidisciplinary and untrained teams    d) Multidisciplinary and trained teams
15. MVP stands for :  
 a) Minimum Value Product    b) Moderate Value Product  
 c) Minimum Viable Product    d) Maximum Viable Production
16. POV is :  
 a) Pin Of View which is 1<sup>st</sup> part of Empathizing  
 b) Point Of View which is last part of Define stage  
 c) Point Of View which is last part of Testing  
 d) Pin Of View which is last part of Prototype.
17. During which stage would you consult experts to learn more about the areas of concern and to gain an understanding of other people’s experiences?  
 a) Prototype    b) Define    c) Ideate    d) Empathize
18. Design thinking is :  
 a) Thinking about design  
 b) Designing ways in which people think  
 c) Asking users to solve problems  
 d) Defining, framing and solving problems from user’s perspectives.
19. To Empathize, one has to  
 a) Observe    b) Engage    c) Listen    d) All of these
20. Collecting \_\_\_\_\_ is an important portion of testing a prototype in the Test Stage of design thinking.  
 a) Pictures    b) Money    c) Feedback    d) E-Mails
21. Agile methodology involved  
 a) sprints    b) no iteration    c) profit    d) none of these

22. Which model provides better collaboration and communication?  
 a) Waterfall model    b) Agile model    c) Both a and b    d) None of these
23. Major difference between Agile model and Water fall model is  
 a) Agile model includes iteration    b) Waterfall model includes iteration  
 c) BPM model include iteration    d) None of these
24. “Invest in user research” – here word “user research” belongs to  
 a) Empathize    b) Design    c) Ideate    d) Testing
25. Parameters which are absolutely necessary in Agile model :  
 a) Transparency    b) Inspection    c) Adaptation    d) All of these
26. \_\_\_\_\_ approach is used for designing complex software systems.  
 a) Scenario based prototyping    b) BPM  
 c) Both a and b    d) None of these
27. \_\_\_\_\_ is type of collaboration where participants regardless of their location, work together to reach a certain GOAL:  
 a) Cloud Computing    b) Off-Line class    c) Distributed Collaboration    d) None of these
28. Digital space is also called as  
 a) Cloud computing    b) Design analysis    c) Distributed Design    d) None of these
29. Example for Distributed collaboration  
 a) Mobile Manufacturing    b) Machine manufacturing    c) Both a and b    d) None of these
30. Design thinking helps in the following :  
 a) Innovation    b) Statistics    c) Data analysis    d) None of these
31. Being an experimental phase, continuous iterations can take place in which phase:  
 a) Define    b) Empathize    c) Prototype    d) None of these
32. Which of the following is not tools of Design thinking?  
 a) Co-creation    b) Prototyping    c) Mind Mapping    d) On-Line Marketing
33. Journey mapping maps which phase of activity of service for a customer?  
 a) Before a service    b) During a service    c) After a service    d) All of these.
34. Value chain analysis examines how an organization interacts with value chain partners to \_\_\_\_\_ new offerings.  
 a) Produce    b) market    c) Distribute    d) All of these.
35. A prototype is simple experimental model of a proposed solution used to :  
 a) Test Ideas    b) Validate Ideas    c) Both a and b    d) None of these
36. A Hypothesis is \_\_\_\_\_.  
 a) statement indicating the profitability of company  
 b) statement indicating the Delivery time of a product  
 c) conjecture that is grounded in support background originating from secondary research  
 d) None of the above
37. What is you first model/design of a product called:  
 a) Draft    b) Rough draft    c) Prototype    d) Practice design



38. To Ideate is :
- To change rapidly
  - creating 3D model of your design
  - Creating and sharing ideas using Images/Sketches to describe your idea
  - Selling a product/service at huge profit
39. A case study is :
- Research strategy
  - Emperical enquiry
  - Descriptive and exploratory analysis
  - All of these
40. At what step, POV (Point Of View) is completed :
- Empathy
  - Prototype
  - Define
  - Ideate
41. The Tool which uses image and allow us to think nonverbally is
- Value chain analysis
  - Journey mapping
  - Visualization
  - Assumption testing
42. Which tool is used as an ethnographic research method that focuses on tracing customer's journey?
- Journey mapping
  - Rapid prototyping
  - Visualization
  - Mind mapping.
43. Which tool is used in generating hypothesis about potential new business opportunities:
- Rapid concept development
  - Mind Mapping
  - Both a and b
  - None of these
44. In value chain analysis client activity includes :
- Order taking
  - Scheduling
  - Software development
  - All of these
45. Which tool is designed to test the value generating assumptions of a potential new growth initiative?
- Visualization
  - Mind Mapping
  - Learning Launches
  - None of these.
46. Select odd one out:
- Brain storming
  - Mind Mapping
  - Empathy
  - Rapid concept
47. Which of the following statement is correct :
- Design thinking is Convergence-Divergence process
  - Design thinking is Lean start-up process
  - Design thinking is Linear process for product development
  - None of the above.
48. In Design thinking, where does the information used to put together a problem statement came from:
- The Define stage
  - Empathize stage
  - Testing state
  - Prototype stage
49. What is the way to narrow down the thoughts to reach at the final solution:
- Convergent thinking
  - Divergent thinking
  - None of these
  - Both a and b
50. The goal of the prototype phase is
- To understand what component of your idea didn't work
  - To understand what component of your idea work
  - Both a and b
  - None of these

\* \* \* \* \*

# CBCS SCHEME

21SFH19/29

USN

--	--	--	--	--	--	--	--	--	--

Question Paper Version : A

**First/Second Semester B.E./B.Tech./B.Arch./B.Planning Degree  
Examination, July/August 2022**

## **Scientific Foundations of Health**

**(COMMON TO ALL BRANCHES)**

Time: 1 hrs.]

[Max. Marks: 50

### **INSTRUCTIONS TO THE CANDIDATES**

1. Answer all the fifty questions, each question carries one mark.
2. Use only **Black ball point pen** for writing / darkening the circles.
3. **For each question, after selecting your answer, darken the appropriate circle corresponding to the same question number on the OMR sheet.**
4. Darkening two circles for the same question makes the answer invalid.
5. **Damaging/overwriting, using whiteners on the OMR sheets are strictly prohibited.**

- 
1. According to WHO, health is
    - a) A state of body and mind in a balanced condition.
    - b) The reflection of a smiling face
    - c) The symbol of economic prosperity
    - d) A state of complete physical, mental and social well-being and not merely the absence of disease or infirmity
  2. Psychosis is characterized by
    - a) Loss of touch with reality
    - b) Prolonged emotional reaction to a given stress
    - c) Anxiety, fear, sadness, vague aches and pains
    - d) All the above
  3. Which one of the following factors affects the development of child?
    - a) Endocrinal glands
    - b) Nutritious diet
    - c) Diseases and injuries
    - d) All of these
  4. Which year did the World Health Organization first express the right to health as a Fundamental Human Right?
    - a) 1946
    - b) 1952
    - c) 1987
    - d) 2000
  5. Which of these things is health psychology concerned with?
    - a) What causes illness?
    - b) Who is responsible for illness?
    - c) How should illness be treated?
    - d) All of these

6. Which of these is not an example of a health behaviour?  
a) Smoking  
b) Taking regular exercise  
c) Eating healthy food  
d) Going to the gym
7. Which statement is wrong in the context of personality?  
a) Personality is unique and specific  
b) Personality is a joint product of heredity and environment  
c) Personality spreads over the subconscious and unconscious behaviour of the person  
d) Personality is limited only to the appearance of a person
8. Who proposed the biopsychosocial model?  
a) Freud  
b) Sontag  
c) Engel  
d) None of these
9. Which of these is not a benefit of mindfulness?  
a) Reduced anxiety and stress  
b) Decreasing depression  
c) Decreased emotional regulation  
d) Better memory
10. Mental health hazards includes  
a) Anxiety  
b) Depression  
c) Organic mental disorders due to substance use  
d) All of the above
11. Which of the following components are major nutrients in our food?  
a) Carbohydrates  
b) Lipids and proteins  
c) Vitamins and minerals  
d) All of these
12. The benefits in eating a balanced diet  
a) good health  
b) good mood and energy  
c) improved health and reduced illness  
d) All of these
13. Nutritional means  
a) Tastes really good  
b) Tastes really bad  
c) Containing necessary substances for the body to grow and stay healthy  
d) Is mostly green
14. In a healthy diet as per WHO the amount of salt to be consumed by a person per day is  
a) less than 5g  
b) less than 5 mg  
c) less than 50 mg  
d) less than 0.5 g
15. BMI stands for  
a) Body Material Index  
b) Body Mass Index  
c) Body Mass Indicator  
d) None of these
16. What is anorexia nervosa?  
a) Nervous system blockage  
b) Sleeping disorder  
c) Eating disorder  
d) Physical disability

17. Which of the following food items provides dietary fibre?  
a) Pulses  
b) Wholegrain  
c) Fruits and vegetables  
d) All of these
18. Which are intimately related?  
a) Diseases and health  
b) Body and health  
c) Body and mind  
d) Body and spiritual values
19. Exercise is often described as training and should include  
a) Exertion of the heart  
b) Exertion of the lungs  
c) Exertion of the muscles  
d) All of these
20. Exercising regularly should be a/an \_\_\_\_\_ not a short-term activity, so think of your progress as part of a long term plan to line better.  
a) Lifestyle  
b) Choice  
c) Obligation  
d) None of these
21. Communication is a  
a) Art of transmitting information, ideas and attitudes from one person  
b) Tool for controlling and motivating people  
c) We can't influence others without communication  
d) (a) and (b)
22. Communication strengthens \_\_\_\_\_ and \_\_\_\_\_ relationships in an organization.  
a) Employee and Employer  
b) Employee and Father  
c) Father and Mother  
d) Friends and Colleagues
23. Our dress code is an example of \_\_\_\_\_ communication.  
a) Verbal  
b) Non-verbal  
c) Written  
d) Spoken
24. From the following identify the skills promoted by communication  
(i) Reading and listening  
(ii) Listening and helping  
(iii) Helping and speaking  
(iv) Speaking and writing  
a) (i) and (ii) only  
b) (ii) and (iii) only  
c) (i) and (iv) only  
d) (iii) and (iv) only
25. Which of the following is not a barrier of effective listening?  
a) Engaging inside conversations  
b) Mentally preparing what you will say next  
c) Being present in the moment  
d) Making judgment about the speaker

26. Body language and facial expressions are related to  
a) Object communication                      b) Written communication  
c) Oral communication                        d) Non-verbal communication
27. Negative characteristics of friendships include all of the following except:  
a) Unsupportive                                b) Oppressive  
c) Criticize in a joking manner              d) Solve problems together
28. Basic instincts of human life  
a) Self preservation                              b) Sexual  
c) Social    d) All of these
29. What are the steps to increase the vocal clarity  
a) Keep your language simple                b) Slow down during conversation  
c) Feedback                                        d) Both (a) and (b)
30. What is the goal of social engineering?  
a) Sabotage a person's social media        b) To gain vital personal information  
c) To catfish someone                         d) To build trust
31. Alcohol abuse and smoke share a window of vulnerability especially during  
a) Adolescence                                  b) Adulthood  
c) Middle age                                      d) Old age
32. Adolescents involved in risky behaviours often have  
a) high self-esteem                                b) a large peer group  
c) poor self-control                                d) a tolerant attitude
33. Chemical dependence is generally known to start between the ages of \_\_\_\_\_  
a) 42 and 51                                        b) 22 and 31  
c) 12 and 21                                        d) 32 and 41
34. Alcoholics anonymous maintains that alcoholism is  
a) a disease that can be cured  
b) a disease that can be managed but never cured  
c) a problem only if a person starts experiencing its synergistic effects  
d) a serious problem only for binge drinkers
35. Which of the following is true of the synergistic effects of smoking?  
a) It helps to reduce stress and maintain a lower body weight  
b) It increases a person's likelihood of engaging in physical exercises  
c) It enhances the detrimental effects of other risk factors  
d) It reduces the chances of early mortality
36. The interaction between weight and smoking can increase one's \_\_\_\_\_.  
a) Mortality                                        b) Self control  
c) Deviant behaviour                              d) Fertility



48. Occurrence in the community of a number of cases of disease that is usually large or unexpected.
- a) Endemic
  - b) Epidemic
  - c) Pandemic
  - d) Infection
49. Leading cause of diarrheal disease
- a) Enterotoxigenic Escherichia coli
  - b) Salmonella (non-typhoid)
  - c) Rotavirus
  - d) Campylobacter jejuni
50. Mammography should be done annually in women of what age?
- a) 50 years old and above
  - b) 60 years old and above
  - c) 45 years old and above
  - d) 30 years old and above

\* \* \* \* \*

# CBCS SCHEME

21SFH19/29

USN

--	--	--	--	--	--	--	--	--	--

Question Paper Version : B

**First/Second Semester B.E./B.Tech./B.Arch./B.Planning Degree  
Examination, July/August 2022**

## **Scientific Foundations of Health**

**(COMMON TO ALL BRANCHES)**

Time: 1 hrs.]

[Max. Marks: 50

### **INSTRUCTIONS TO THE CANDIDATES**

1. Answer all the fifty questions, each question carries one mark.
2. Use only **Black ball point pen** for writing / darkening the circles.
3. **For each question, after selecting your answer, darken the appropriate circle corresponding to the same question number on the OMR sheet.**
4. Darkening two circles for the same question makes the answer invalid.
5. **Damaging/overwriting, using whiteners** on the **OMR** sheets are strictly prohibited.

- 
1. How are infectious diseases, such as colds and influenza, most commonly spread?  
a) Breathing viruses in air  
b) Hand-to-face contact  
c) Drinking infected water  
d) Eating contaminated food
  2. Which is the most important hygiene habit to teach young children?  
a) Use a tissue to cover a sneeze  
b) Don't share a glass or eating utensil  
c) Wash hands frequently  
d) Take a bath daily
  3. Chronic stress has been linked to which of these health problems?  
a) Headaches  
b) Constipation  
c) Depression  
d) All of these
  4. Which of the following increases your risk for type 2 diabetes?  
a) Not getting enough exercise  
b) Eating too much sugar  
c) Being overweight  
d) (a) and (c)
  5. According to CDC, when should infants start vaccines against serious diseases?  
a) Birth  
b) 2 months old  
c) 6 weeks old  
d) 6 months old
  6. Modes of horizontal transmission of disease, except  
a) Contact  
b) Vector  
c) Common vehicle  
d) Genetic



7. An infected person is less likely to encounter a susceptible person when a large proportion of the members of the group are immune.
- a) Active immunity
  - b) Passive immunity
  - c) Herd immunity
  - d) Specific immunity
8. Occurrence in the community of a number of cases of disease that is usually large or unexpected.
- a) Endemic
  - b) Epidemic
  - c) Pandemic
  - d) Infection
9. Leading cause of diarrheal disease
- a) Enterotoxigenic Escherichia coli
  - b) Salmonella (non-typhoid)
  - c) Rotavirus
  - d) Campylobacter jejuni
10. Mammography should be done annually in women of what age?
- a) 50 years old and above
  - b) 60 years old and above
  - c) 45 years old and above
  - d) 30 years old and above
11. Alcohol abuse and smoke share a window of vulnerability especially during
- a) Adolescence
  - b) Adulthood
  - c) Middle age
  - d) Old age
12. Adolescents involved in risky behaviours often have
- a) high self-esteem
  - b) a large peer group
  - c) poor self-control
  - d) a tolerant attitude
13. Chemical dependence is generally known to start between the ages of \_\_\_\_\_
- a) 42 and 51
  - b) 22 and 31
  - c) 12 and 21
  - d) 32 and 41
14. Alcoholics anonymous maintains that alcoholism is
- a) a disease that can be cured
  - b) a disease that can be managed but never cured
  - c) a problem only if a person starts experiencing its synergistic effects
  - d) a serious problem only for binge drinkers
15. Which of the following is true of the synergistic effects of smoking?
- a) It helps to reduce stress and maintain a lower body weight
  - b) It increases a person's likelihood of engaging in physical exercises
  - c) It enhances the detrimental effects of other risk factors
  - d) It reduces the chances of early mortality
16. The interaction between weight and smoking can increase one's \_\_\_\_\_.
- a) Mortality
  - b) Self control
  - c) Deviant behaviour
  - d) Fertility

17. Which of the following is not a characteristic of addiction?  
a) Habitual behaviour  
b) Loss of control  
c) Negative consequence  
d) Denial
18. Addiction involves an excessive  
a) Tolerance for alcohol or drugs  
b) Amount of debt or financial problems  
c) Preoccupation with the addictive behaviour  
d) Risk of losing one's job or failing out of school
19. Temporary physical and psychological symptoms that occur when use of an addictive substance is discontinued is  
a) Relapse  
b) Compulsion  
c) Withdrawal  
d) Addiction
20. Transdermal drug administration means that a drug is  
a) Placed under the tongue  
b) Injected into a vein  
c) Absorbed through the skin  
d) Inhaled
21. Which of the following components are major nutrients in our food?  
a) Carbohydrates  
b) Lipids and proteins  
c) Vitamins and minerals  
d) All of these
22. The benefits in eating a balanced diet  
a) good health  
b) good mood and energy  
c) improved health and reduced illness  
d) All of these
23. Nutritional means  
a) Tastes really good  
b) Tastes really bad  
c) Containing necessary substances for the body to grow and stay healthy  
d) Is mostly green
24. In a healthy diet as per WHO the amount of salt to be consumed by a person per day is  
a) less than 5g  
b) less than 5 mg  
c) less than 50 mg  
d) less than 0.5 g
25. BMI stands for  
a) Body Material Index  
b) Body Mass Index  
c) Body Mass Indicator  
d) None of these
26. What is anorexia nervosa?  
a) Nervous system blockage  
b) Sleeping disorder  
c) Eating disorder  
d) Physical disability
27. Which of the following food items provides dietary fibre?  
a) Pulses  
b) Wholegrain  
c) Fruits and vegetables  
d) All of these

28. Which are intimately related?  
a) Diseases and health  
b) Body and health  
c) Body and mind  
d) Body and spiritual values
29. Exercise is often described as training and should include  
a) Exertion of the heart  
b) Exertion of the lungs  
c) Exertion of the muscles  
d) All of these
30. Exercising regularly should be a/an \_\_\_\_\_ not a short-term activity, so think of your progress as part of a long term plan to line better.  
a) Lifestyle  
b) Choice  
c) Obligation  
d) None of these
31. According to WHO, health is  
a) A state of body and mind in a balanced condition.  
b) The reflection of a smiling face  
c) The symbol of economic prosperity  
d) A state of complete physical, mental and social well-being and not merely the absence of disease or infirmity
32. Psychosis is characterized by  
a) Loss of touch with reality  
b) Prolonged emotional reaction to a given stress  
c) Anxiety, fear, sadness, vague aches and pains  
d) All the above
33. Which one of the following factors affects the development of child?  
a) Endocrinal glands  
b) Nutritious diet  
c) Diseases and injuries  
d) All of these
34. Which year did the World Health Organization first express the right to health as a Fundamental Human Right?  
a) 1946  
b) 1952  
c) 1987  
d) 2000
35. Which of these things is health psychology concerned with?  
a) What causes illness?  
b) Who is responsible for illness?  
c) How should illness be treated?  
d) All of these
36. Which of these is not an example of a health behaviour?  
a) Smoking  
b) Taking regular exercise  
c) Eating healthy food  
d) Going to the gym
37. Which statement is wrong in the context of personality?  
a) Personality is unique and specific  
b) Personality is a joint product of heredity and environment  
c) Personality spreads over the subconscious and unconscious behaviour of the person  
d) Personality is limited only to the appearance of a person

38. Who proposed the biopsychosocial model?  
a) Freud  
b) Sontag  
c) Engel  
d) None of these
39. Which of these is not a benefit of mindfulness?  
a) Reduced anxiety and stress  
b) Decreasing depression  
c) Decreased emotional regulation  
d) Better memory
40. Mental health hazards includes  
a) Anxiety  
b) Depression  
c) Organic mental disorders due to substance use  
d) All of the above
41. Communication is a  
a) Art of transmitting information, ideas and attitudes from one person  
b) Tool for controlling and motivating people  
c) We can't influence others without communication  
d) (a) and (b)
42. Communication strengthens \_\_\_\_\_ and \_\_\_\_\_ relationships in an organization.  
a) Employee and Employer  
b) Employee and Father  
c) Father and Mother  
d) Friends and Colleagues
43. Our dress code is an example of \_\_\_\_\_ communication.  
a) Verbal  
b) Non-verbal  
c) Written  
d) Spoken
44. From the following identify the skills promoted by communication  
(i) Reading and listening  
(ii) Listening and helping  
(iii) Helping and speaking  
(iv) Speaking and writing  
a) (i) and (ii) only  
b) (ii) and (iii) only  
c) (i) and (iv) only  
d) (iii) and (iv) only
45. Which of the following is not a barrier of effective listening?  
a) Engaging inside conversations  
b) Mentally preparing what you will say next  
c) Being present in the moment  
d) Making judgment about the speaker
46. Body language and facial expressions are related to  
a) Object communication  
b) Written communication  
c) Oral communication  
d) Non-verbal communication



# CBCS SCHEME

21SFH19/29

USN

--	--	--	--	--	--	--	--	--	--

Question Paper Version : C

**First/Second Semester B.E./B.Tech./B.Arch./B.Planning Degree  
Examination, July/August 2022**

## **Scientific Foundations of Health**

**(COMMON TO ALL BRANCHES)**

Time: 1 hrs.]

[Max. Marks: 50

### **INSTRUCTIONS TO THE CANDIDATES**

1. Answer all the fifty questions, each question carries one mark.
2. Use only **Black ball point pen** for writing / darkening the circles.
3. **For each question, after selecting your answer, darken the appropriate circle corresponding to the same question number on the OMR sheet.**
4. Darkening two circles for the same question makes the answer invalid.
5. **Damaging/overwriting, using whiteners** on the **OMR** sheets are strictly prohibited.

- 
1. Communication is a
    - a) Art of transmitting information, ideas and attitudes from one person
    - b) Tool for controlling and motivating people
    - c) We can't influence others without communication
    - d) (a) and (b)
  2. Communication strengthens \_\_\_\_\_ and \_\_\_\_\_ relationships in an organization.
    - a) Employee and Employer
    - b) Employee and Father
    - c) Father and Mother
    - d) Friends and Colleagues
  3. Our dress code is an example of \_\_\_\_\_ communication.
    - a) Verbal
    - b) Non-verbal
    - c) Written
    - d) Spoken
  4. From the following identify the skills promoted by communication
    - (i) Reading and listening
    - (ii) Listening and helping
    - (iii) Helping and speaking
    - (iv) Speaking and writing
    - a) (i) and (ii) only
    - b) (ii) and (iii) only
    - c) (i) and (iv) only
    - d) (iii) and (iv) only

5. Which of the following is not a barrier of effective listening?
  - a) Engaging in conversations
  - b) Mentally preparing what you will say next
  - c) Being present in the moment
  - d) Making judgment about the speaker
6. Body language and facial expressions are related to
  - a) Object communication
  - b) Written communication
  - c) Oral communication
  - d) Non-verbal communication
7. Negative characteristics of friendships include all of the following except:
  - a) Unsupportive
  - b) Oppressive
  - c) Criticize in a joking manner
  - d) Solve problems together
8. Basic instincts of human life
  - a) Self preservation
  - b) Sexual
  - c) Social
  - d) All of these
9. What are the steps to increase the vocal clarity
  - a) Keep your language simple
  - b) Slow down during conversation
  - c) Feedback
  - d) Both (a) and (b)
10. What is the goal of social engineering?
  - a) Sabotage a person's social media
  - b) To gain vital personal information
  - c) To catfish someone
  - d) To build trust
11. How are infectious diseases, such as colds and influenza, most commonly spread?
  - a) Breathing viruses in
  - b) Hand-to-face contact
  - c) Drinking infected water
  - d) Eating contaminated food
12. Which is the most important hygiene habit to teach young children?
  - a) Use a tissue to cover a sneeze
  - b) Don't share a glass or eating utensil
  - c) Wash hands frequently
  - d) Take a bath daily
13. Chronic stress has been linked to which of these health problems?
  - a) Headaches
  - b) Constipation
  - c) Depression
  - d) All of these
14. Which of the following increases your risk for type 2 diabetes?
  - a) Not getting enough exercise
  - b) Eating too much sugar
  - c) Being overweight
  - d) (a) and (c)
15. According to CDC, when should infants start vaccines against serious diseases?
  - a) Birth
  - b) 2 months old
  - c) 6 weeks old
  - d) 6 months old

16. Modes of horizontal transmission of disease, except  
a) Contact  
b) Vector  
c) Common vehicle  
d) Genetic
17. An infected person is less likely to encounter a susceptible person when a large proportion of the members of the group are immune.  
a) Active immunity  
b) Passive immunity  
c) Herd immunity  
d) Specific immunity
18. Occurrence in the community of a number of cases of disease that is usually large or unexpected.  
a) Endemic  
b) Epidemic  
c) Pandemic  
d) Infection
19. Leading cause of diarrheal disease  
a) Enterotoxigenic Escherichia coli  
b) Salmonella (non-typhoid)  
c) Rotavirus  
d) Campylobacter jejuni
20. Mammography should be done annually in women of what age?  
a) 50 years old and above  
b) 60 years old and above  
c) 45 years old and above  
d) 30 years old and above
21. Alcohol abuse and smoke share a window of vulnerability especially during  
a) Adolescence  
b) Adulthood  
c) Middle age  
d) Old age
22. Adolescents involved in risky behaviours often have  
a) high self-esteem  
b) a large peer group  
c) poor self-control  
d) a tolerant attitude
23. Chemical dependence is generally known to start between the ages of \_\_\_\_\_  
a) 42 and 51  
b) 22 and 31  
c) 12 and 21  
d) 32 and 41
24. Alcoholics anonymous maintains that alcoholism is  
a) a disease that can be cured  
b) a disease that can be managed but never cured  
c) a problem only if a person starts experiencing its synergistic effects  
d) a serious problem only for binge drinkers
25. Which of the following is true of the synergistic effects of smoking?  
a) It helps to reduce stress and maintain a lower body weight  
b) It increases a person's likelihood of engaging in physical exercises  
c) It enhances the detrimental effects of other risk factors  
d) It reduces the chances of early mortality
26. The interaction between weight and smoking can increase one's \_\_\_\_\_.  
a) Mortality  
b) Self control  
c) Deviant behaviour  
d) Fertility



27. Which of the following is not a characteristic of addiction?  
a) Habitual behaviour  
b) Loss of control  
c) Negative consequence  
d) Denial
28. Addiction involves an excessive  
a) Tolerance for alcohol or drugs  
b) Amount of debt or financial problems  
c) Preoccupation with the addictive behaviour  
d) Risk of losing one's job or failing out of school
29. Temporary physical and psychological symptoms that occur when use of an addictive substance is discontinued is  
a) Relapse  
b) Compulsion  
c) Withdrawal  
d) Addiction
30. Transdermal drug administration means that a drug is  
a) Placed under the tongue  
b) Injected into a vein  
c) Absorbed through the skin  
d) Inhaled
31. Which of the following components are major nutrients in our food?  
a) Carbohydrates  
b) Lipids and proteins  
c) Vitamins and minerals  
d) All of these
32. The benefits in eating a balanced diet  
a) good health  
b) good mood and energy  
c) improved health and reduced illness  
d) All of these
33. Nutritional means  
a) Tastes really good  
b) Tastes really bad  
c) Containing necessary substances for the body to grow and stay healthy  
d) Is mostly green
34. In a healthy diet as per WHO the amount of salt to be consumed by a person per day is  
a) less than 5g  
b) less than 5 mg  
c) less than 50 mg  
d) less than 0.5 g
35. BMI stands for  
a) Body Material Index  
b) Body Mass Index  
c) Body Mass Indicator  
d) None of these
36. What is anorexia nervosa?  
a) Nervous system blockage  
b) Sleeping disorder  
c) Eating disorder  
d) Physical disability
37. Which of the following food items provides dietary fibre?  
a) Pulses  
b) Wholegrain  
c) Fruits and vegetables  
d) All of these

38. Which are intimately related?  
a) Diseases and health  
b) Body and health  
c) Body and mind  
d) Body and spiritual values
39. Exercise is often described as training and should include  
a) Exertion of the heart  
b) Exertion of the lungs  
c) Exertion of the muscles  
d) All of these
40. Exercising regularly should be a/an \_\_\_\_\_ not a short-term activity, so think of your progress as part of a long term plan to line better.  
a) Lifestyle  
b) Choice  
c) Obligation  
d) None of these
41. According to WHO, health is  
a) A state of body and mind in a balanced condition.  
b) The reflection of a smiling face  
c) The symbol of economic prosperity  
d) A state of complete physical, mental and social well-being and not merely the absence of disease or infirmity
42. Psychosis is characterized by  
a) Loss of touch with reality  
b) Prolonged emotional reaction to a given stress  
c) Anxiety, fear, sadness, vague aches and pains  
d) All the above
43. Which one of the following factors affects the development of child?  
a) Endocrinal glands  
b) Nutritious diet  
c) Diseases and injuries  
d) All of these
44. Which year did the World Health Organization first express the right to health as a Fundamental Human Right?  
a) 1946  
b) 1952  
c) 1987  
d) 2000
45. Which of these things is health psychology concerned with?  
a) What causes illness?  
b) Who is responsible for illness?  
c) How should illness be treated?  
d) All of these
46. Which of these is not an example of a health behaviour?  
a) Smoking  
b) Taking regular exercise  
c) Eating healthy food  
d) Going to the gym
47. Which statement is wrong in the context of personality?  
a) Personality is unique and specific  
b) Personality is a joint product of heredity and environment  
c) Personality spreads over the subconscious and unconscious behaviour of the person  
d) Personality is limited only to the appearance of a person

48. Who proposed the biopsychosocial model?  
a) Freud  
b) Sontag  
c) Engel  
d) None of these
49. Which of these is not a benefit of mindfulness?  
a) Reduced anxiety and stress  
b) Decreasing depression  
c) Decreased emotional regulation  
d) Better memory
50. Mental health hazards includes  
a) Anxiety  
b) Depression  
c) Organic mental disorders due to substance use  
d) All of the above

\* \* \* \* \*

# CBCS SCHEME

21SFH19/29

USN

--	--	--	--	--	--	--	--	--	--

Question Paper Version : D

**First/Second Semester B.E./B.Tech./B.Arch./B.Planning Degree  
Examination, July/August 2022**

## **Scientific Foundations of Health**

**(COMMON TO ALL BRANCHES)**

Time: 1 hrs.]

[Max. Marks: 50

### **INSTRUCTIONS TO THE CANDIDATES**

1. Answer all the fifty questions, each question carries one mark.
2. Use only **Black ball point pen** for writing / darkening the circles.
3. **For each question, after selecting your answer, darken the appropriate circle corresponding to the same question number on the OMR sheet.**
4. Darkening two circles for the same question makes the answer invalid.
5. **Damaging/overwriting, using whiteners on the OMR sheets are strictly prohibited.**

- 
1. Alcohol abuse and smoke share a window of vulnerability especially during
    - a) Adolescence
    - b) Adulthood
    - c) Middle age
    - d) Old age
  2. Adolescents involved in risky behaviours often have
    - a) high self-esteem
    - b) a large peer group
    - c) poor self-control
    - d) a tolerant attitude
  3. Chemical dependence is generally known to start between the ages of \_\_\_\_\_
    - a) 42 and 51
    - b) 22 and 31
    - c) 12 and 21
    - d) 32 and 41
  4. Alcoholics anonymous maintains that alcoholism is
    - a) a disease that can be cured
    - b) a disease that can be managed but never cured
    - c) a problem only if a person starts experiencing its synergistic effects
    - d) a serious problem only for binge drinkers
  5. Which of the following is true of the synergistic effects of smoking?
    - a) It helps to reduce stress and maintain a lower body weight
    - b) It increases a person's likelihood of engaging in physical exercises
    - c) It enhances the detrimental effects of other risk factors
    - d) It reduces the chances of early mortality

6. The interaction between weight and smoking can increase one's \_\_\_\_\_.  
a) Mortality  
b) Self control  
c) Deviant behaviour  
d) Fertility
7. Which of the following is not a characteristic of addiction?  
a) Habitual behaviour  
b) Loss of control  
c) Negative consequence  
d) Denial
8. Addiction involves an excessive  
a) Tolerance for alcohol or drugs  
b) Amount of debt or financial problems  
c) Preoccupation with the addictive behaviour  
d) Risk of losing one's job or failing out of school
9. Temporary physical and psychological symptoms that occur when use of an addictive substance is discontinued is  
a) Relapse  
b) Compulsion  
c) Withdrawal  
d) Addiction
10. Transdermal drug administration means that a drug is  
a) Placed under the tongue  
b) Injected into a vein  
c) Absorbed through the skin  
d) Inhaled
11. According to WHO, health is  
a) A state of body and mind in a balanced condition.  
b) The reflection of a smiling face  
c) The symbol of economic prosperity  
d) A state of complete physical, mental and social well-being and not merely the absence of disease or infirmity
12. Psychosis is characterized by  
a) Loss of touch with reality  
b) Prolonged emotional reaction to a given stress  
c) Anxiety, fear, sadness, vague aches and pains  
d) All the above
13. Which one of the following factors affects the development of child?  
a) Endocrinal glands  
b) Nutritious diet  
c) Diseases and injuries  
d) All of these
14. Which year did the World Health Organization first express the right to health as a Fundamental Human Right?  
a) 1946  
b) 1952  
c) 1987  
d) 2000
15. Which of these things is health psychology concerned with?  
a) What causes illness?  
b) Who is responsible for illness?  
c) How should illness be treated?  
d) All of these

16. Which of these is not an example of a health behaviour?  
a) Smoking  
b) Taking regular exercise  
c) Eating healthy food  
d) Going to the gym
17. Which statement is wrong in the context of personality?  
a) Personality is unique and specific  
b) Personality is a joint product of heredity and environment  
c) Personality spreads over the subconscious and unconscious behaviour of the person  
d) Personality is limited only to the appearance of a person
18. Who proposed the biopsychosocial model?  
a) Freud  
b) Sontag  
c) Engel  
d) None of these
19. Which of these is not a benefit of mindfulness?  
a) Reduced anxiety and stress  
b) Decreasing depression  
c) Decreased emotional regulation  
d) Better memory
20. Mental health hazards includes  
a) Anxiety  
b) Depression  
c) Organic mental disorders due to substance use  
d) All of the above
21. How are infectious diseases, such as colds and influenza, most commonly spread?  
a) Breathing viruses in  
b) Hand-to-face contact  
c) Drinking infected water  
d) Eating contaminated food
22. Which is the most important hygiene habit to teach young children?  
a) Use a tissue to cover a sneeze  
b) Don't share a glass or eating utensil  
c) Wash hands frequently  
d) Take a bath daily
23. Chronic stress has been linked to which of these health problems?  
a) Headaches  
b) Constipation  
c) Depression  
d) All of these
24. Which of the following increases your risk for type 2 diabetes?  
a) Not getting enough exercise  
b) Eating too much sugar  
c) Being overweight  
d) (a) and (c)
25. According to CDC, when should infants start vaccines against serious diseases?  
a) Birth  
b) 2 months old  
c) 6 weeks old  
d) 6 months old
26. Modes of horizontal transmission of disease, except  
a) Contact  
b) Vector  
c) Common vehicle  
d) Genetic

27. An infected person is less likely to encounter a susceptible person when a large proportion of the members of the group are immune.
- a) Active immunity
  - b) Passive immunity
  - c) Herd immunity
  - d) Specific immunity
28. Occurrence in the community of a number of cases of disease that is usually large or unexpected.
- a) Endemic
  - b) Epidemic
  - c) Pandemic
  - d) Infection
29. Leading cause of diarrheal disease
- a) Enterotoxigenic Escherichia coli
  - b) Salmonella (non-typhoid)
  - c) Rotavirus
  - d) Campylobacter jejuni
30. Mammography should be done annually in women of what age?
- a) 50 years old and above
  - b) 60 years old and above
  - c) 45 years old and above
  - d) 30 years old and above
31. Communication is a
- a) Art of transmitting information, ideas and attitudes from one person
  - b) Tool for controlling and motivating people
  - c) We can't influence others without communication
  - d) (a) and (b)
32. Communication strengthens \_\_\_\_\_ and \_\_\_\_\_ relationships in an organization.
- a) Employee and Employer
  - b) Employee and Father
  - c) Father and Mother
  - d) Friends and Colleagues
33. Our dress code is an example of \_\_\_\_\_ communication.
- a) Verbal
  - b) Non-verbal
  - c) Written
  - d) Spoken
34. From the following identify the skills promoted by communication
- (i) Reading and listening
  - (ii) Listening and helping
  - (iii) Helping and speaking
  - (iv) Speaking and writing
- a) (i) and (ii) only
  - b) (ii) and (iii) only
  - c) (i) and (iv) only
  - d) (iii) and (iv) only
35. Which of the following is not a barrier of effective listening?
- a) Engaging inside conversations
  - b) Mentally preparing what you will say next
  - c) Being present in the moment
  - d) Making judgment about the speaker

36. Body language and facial expressions are related to  
a) Object communication                      b) Written communication  
c) Oral communication                      d) Non-verbal communication
37. Negative characteristics of friendships include all of the following except:  
a) Unsupportive                      b) Oppressive  
c) Criticize in a joking manner                      d) Solve problems together
38. Basic instincts of human life  
a) Self preservation                      b) Sexual  
c) Social                      d) All of these
39. What are the steps to increase the vocal clarity  
a) Keep your language simple                      b) Slow down during conversation  
c) Feedback                      d) Both (a) and (b)
40. What is the goal of social engineering?  
a) Sabotage a person's social media                      b) To gain vital personal information  
c) To catfish someone                      d) To build trust
41. Which of the following components are major nutrients in our food?  
a) Carbohydrates                      b) Lipids and proteins  
c) Vitamins and minerals                      d) All of these
42. The benefits in eating a balanced diet  
a) good health                      b) good mood and energy  
c) improved health and reduced illness                      d) All of these
43. Nutritional means  
a) Tastes really good  
b) Tastes really bad  
c) Containing necessary substances for the body to grow and stay healthy  
d) Is mostly green
44. In a healthy diet as per WHO the amount of salt to be consumed by a person per day is  
a) less than 5g                      b) less than 5 mg  
c) less than 50 mg                      d) less than 0.5 g
45. BMI stands for  
a) Body Material Index                      b) Body Mass Index  
c) Body Mass Indicator                      d) None of these
46. What is anorexia nervosa?  
a) Nervous system blockage                      b) Sleeping disorder  
c) Eating disorder                      d) Physical disability



47. Which of the following food items provides dietary fibre?  
a) Pulses  
b) Wholegrain  
c) Fruits and vegetables  
d) All of these
48. Which are intimately related?  
a) Diseases and health  
b) Body and health  
c) Body and mind  
d) Body and spiritual values
49. Exercise is often described as training and should include  
a) Exertion of the heart  
b) Exertion of the lungs  
c) Exertion of the muscles  
d) All of these
50. Exercising regularly should be a/an \_\_\_\_\_ not a short-term activity, so think of your progress as part of a long term plan to line better.  
a) Lifestyle  
b) Choice  
c) Obligation  
d) None of these

\* \* \* \* \*